

MM11

THE FOLLOWING MODULE/ASSEMBLIES ARE CONTAINED IN THIS DEVICE. EACH MAY HAVE ASSOCIATED TECH TIPS,
DEC-O-LOG AND FCO's DOCUMENTED IN THE MODULE/ASSEMBLY CATEGORY OF THE MICROFICHE LIBRARY.

70-06468
70-07263
70-09562

G102
G103
G109
G110
G225
G226
G231
G615
G616
G645

H213
H214

M109
M229
M1091
M7290

TECH. TIPS

digital	FIELD SERVICE TECHNICAL MANUAL				Option or Designator
	12 Bit <input type="checkbox"/>	16 Bit <input checked="" type="checkbox"/>	18 Bit <input type="checkbox"/>	36 Bit <input type="checkbox"/>	MM11

Title QUALADYNE 1540 SENSE AMPS				Tech Tip MM11 Number 01	
All	Processor Applicability		Author DON ZERESKI	Rev A	Cross Reference
			Approval CHUCK DEWEY	Date 6/27/72	

The Qualadyne 1540 sense amps have had bonding problems. The unit is used in most current DEC sense amplifier boards. The Motorola 1540 should be used as its replacement when necessary. Most of the defective units have been replaced during production. These were used in MM11-E and F memories.

Since the Motorola 1540 units are in short supply, Production is only replacing failing units and are not retrofitting all boards in all product lines. Machines in the field that exhibit strange memory problems that can be localized to sense amp problems should be checked for Qualadyne units with the following date codes: 7014, 7016, 7020, 7022, 7024, 7031, and 7032. These units may be defective and should be replaced as a last resort. We are not suggesting a purge of all Qualadyne units of the above mentioned date codes or future Qualadyne units.

Title H207E MEMORY STACK				Tech Tip MM11 Number 02	
All	Processor Applicability		Author TOM KARPOWSKI	Rev A	Cross Reference
			Approval CHUCK DEWEY	Date 6/27/72	

The MM11-E memory will be using a new stack, RCA's H207E. This stack can only be used in an MM11-E. The H207 stack can be used in an MM11-E and MM11-F.

Title MM11-E & F/G102 MODULES				Tech Tip MM11 Number 03	
All	Processor Applicability		Author TOM KARPOWSKI	Rev B	Cross Reference
			Approval CHUCK DEWEY	Date 6/1/72	

ECO G102-00005 has been written to make the G102 module capable of running in the MM11-F memory. This ECO makes this module CS revision D. It has to be at least revision D to run in an MM11-F. This revision can also be used in MM11-E's. Please see that your spares are modified accordingly.

Title INTERLEAVING THE MM11-E MEMORY				Tech Tip MM11 Number 04	
All	Processor Applicability		Author JOHN BUZYNSKI	Rev g	Cross Reference
			Approval CHUCK DEWEY	Date 6/1/72	

Interleaving is simply addressing the memory such that adjacent memory banks are selected on alternate cycles. Thus, it is interleavable in 8K increments or blocks. This is implemented by interchanging BUS A01L and BUS A13L inputs to the memory between the bus inputs and memory device select and control. The memory being addressed, for example, in a DAT1 mode is free to complete its cycle after the MSYN L-SSYN I dialog and as soon as the setup times for the bus are satisfied, MSYN L can be reasserted to

Title INTERLEAVING THE M11-E MEMORY (Continued)				Tech Tip M11 Number 04	
All	Processor Applicability			Author JOHN BUZYNSKI	Rev g
				Approval CHUCK DENEY	Date 6/1/72
Cross Reference					

start a memory cycle in the adjacent memory bank while the first memory bank is completing its cycle. A significant increase in memory throughput occurs.

In the M11-E the two address bits have to be physically interchanged on the back-plane. It is also necessary to modify M729 control logic module to speed up the SSYNL reset circuit. (Refer to ECO's M11-E Numbers 17, 19, and 20; M729 number 2; and ECO M1091 number 1).

Remember, when troubleshooting an interleaved memory, that successive addresses reference alternate memory banks.

Title FIELD INSTALLATION OF M11-E ON PDP-11/45				Tech Tip M11 Number 05	
All	Processor Applicability			Author ANDY VEROSTIC	Rev g
	11/45			Approval ART ZINS	Date 6/7/72
Cross Reference					

HARDWARE

Existing M729 control must have ECO #M729-00003 installed for operation on 11/45.

DIAGNOSTICS

All present memory tests will run on the 11/45.

Title FIELD INSTALLATION OF M11-F ON PDP-11/45				Tech Tip M11 Number 06	
All	Processor Applicability			Author ANDY VEROSTIC	Rev. A
	11/45			Approval ART ZINS	Date 6/7/72
Cross Reference					

HARDWARE

Existing M7290 control must have ECO's #M7290-00002 and 00003 installed for proper operation on the 11/45.

DIAGNOSTICS

All present memory tests run on the 11/45.

digital	FIELD SERVICE TECHNICAL MANUAL				Option or Designator
	12 Bit <input type="checkbox"/>	16 Bit <input checked="" type="checkbox"/>	18 Bit <input type="checkbox"/>	36 Bit <input type="checkbox"/>	MM11

Title MM11-E and F MEMORY ADDRESS SELECTION AND INTERLEAVING				Tech Tip MM11-TT Number 07	
All	Processor Applicability		Author Chuck Dewey	Rev 0	Cross Reference
			Approval Chuck Dewey	Date 9/28/72	

Address Selection

MM11-E Memories have had two types of address selection modules. The M109 was the original address selector and may still be found in some installations. The M109 causes insertion of two UNIBUS unit loads. This was corrected when the M1091 was introduced (ECO M1091-00001). Selection of addresses when using M109 is described in the hardware manual (DEC-11-HR3B-D).

Both the MM11-E and MM11-F memories now utilize M1091 address selector modules. Figure 2 shows the circuit schematic of the M1091 address selection logic. Figure 1 shows a layout of that portion of the physical module where the addressing is accomplished by insertion or removal of jumper wires. Table 1 lists the following:

- a. Bank Number - These numbers are indicative of the physical system units of MM11-E or F memories.
- b. K Words - This indicates the word quantity for a specific bank in thousands (K) words.
- c. Addresses - The inclusive (octal) word (two byte) addresses within a specific bank of memory are listed here. They assume a non-interleaved configuration.
- d. Bits 17, 16, 15, 14, 13 and 01 Non-Interleaved
These columns show, by an X, that jumper which should be installed in order to respond to a specific memory bank addressing. The 1, 0, A, B, C and D correspond to the identification shown on the module, figure 1, and figure 2.
- e. Bits 13, and 01 Interleaved - These two bits accomplish the interleaving for MM11-F memories and are to be used in place of their counterparts listed for d, above. When used these cause modification of two 4K Banks so that their addressing has the lower (odd) bank with addresses ending with 0 or 4 and upper (even) bank ending with 2 or 6.

Title		MM11-E and F MEMORY ADDRESS SELECTION AND INTERLEAVING		Tech Tip		MM11-TT	
All		Processor Applicability		Author		Chuck Dewey	
				Rev		g	
		Approval		Date		9/28/72	
				Cross Reference			

Interleaving

Interleaving for MM11-E memories is described in Tech Tip MM11 number 4. It can only be accomplished by system unit wire changes to the back plane. Refer to the ECO's, listed in the Tech Tip, for proper implementation.

MM11-F interleaving is accomplished by manipulation of jumper wires on the M1091 module. These changes are shown in Table 1. It is a normal procedure for the production line to interleave all 8K segments of MM11-F memory on the initial system prior to shipment.

Interleaving of a MM11-E with an MM11-F is not recommended primarily due to the confusion it creates when troubleshooting a system of this nature. It also creates customer misunderstanding since the average memory cycle time specification, in this situation, would not be either the MM11-E or F but somewhere in between.

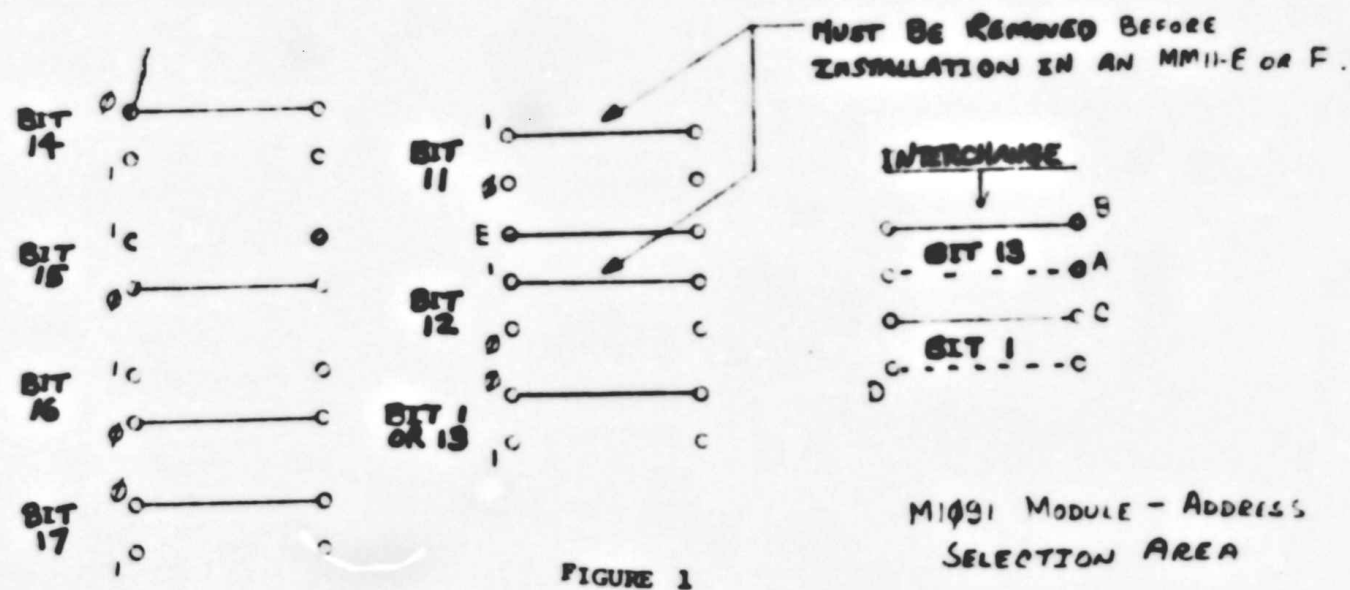

digital	FIELD SERVICE TECHNICAL MANUAL				Option or Designator
	12 Bit <input type="checkbox"/>	16 Bit <input checked="" type="checkbox"/>	18 Bit <input type="checkbox"/>	36 Bit <input type="checkbox"/>	MM11
Title MM11-E and F MEMORY ADDRESS SELECTION & INTERLEAVING (CONT'D)				Tech Tip Number	MM11-TT 87
All Processor Applicability		Author	Rev	Cross Reference	
		Chuck Dewey	g		
		Approval	Date		
		Chuck Dewey	9/28/72		

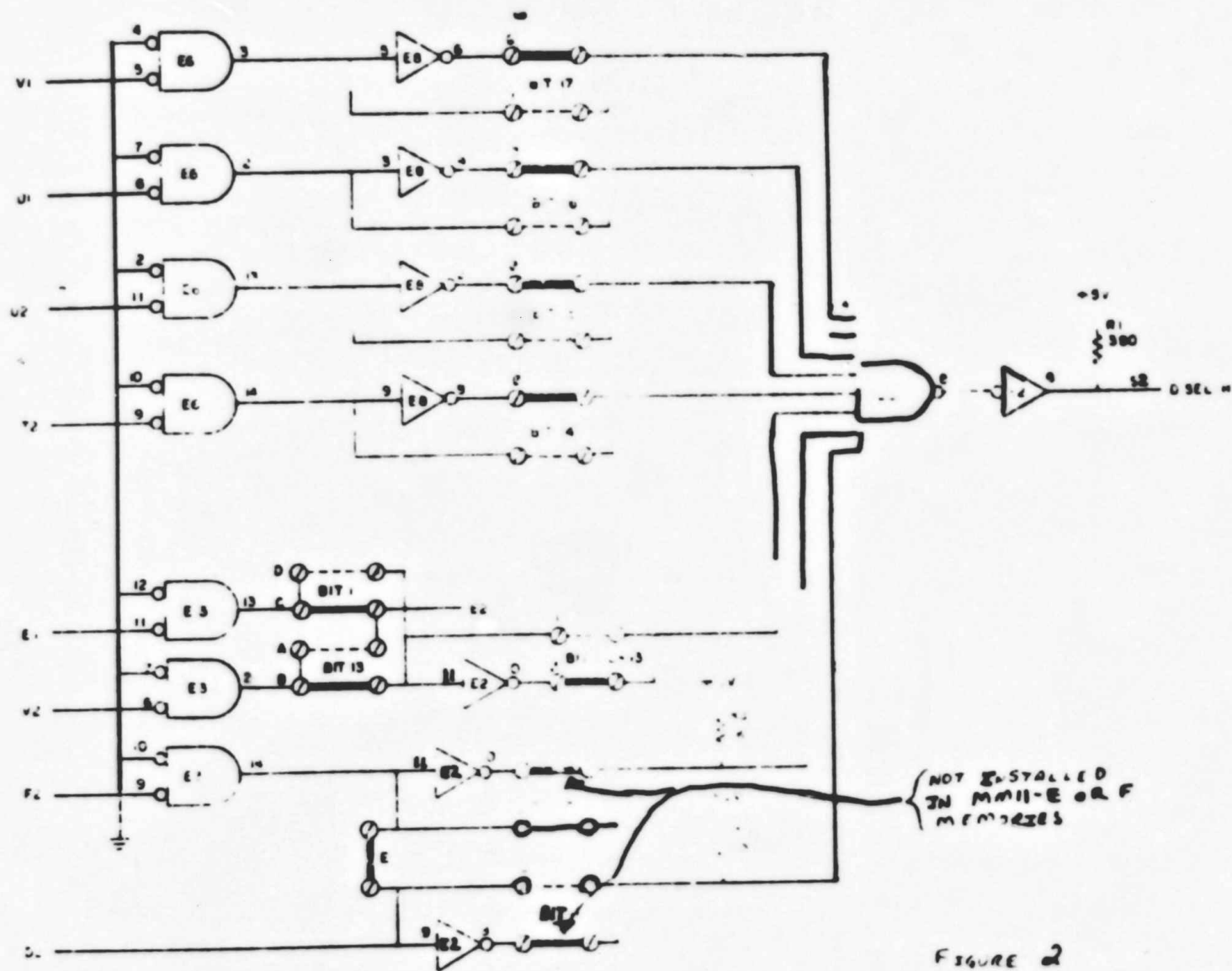

FIGURE 2

THIS DOCUMENT WAS NOT PRODUCED FOR MICROFICHE; THEREFORE, ONLY PARTS OF IT ARE READABLE.

Title MM11-E and F MEMORY ADDRESS SELECTION & INTERLEAVING (CONT'D)				Tech Tip MM11-TT	
All Processor Applicability				Number 07	
Author Chuck Dewey		Rev 0		Cross Reference	
Approval Chuck Dewey		Date 9/28/72			

TABLE 1

BANK	K WORDS	NON-INTERLEAVED MM11-F AND ALL MM11-E MEMORIES										INTERLEAVED MM11-F MEMORY *							
		ADDRESSES		17		16		15		14		13		01		13		01	
		FROM	TO	1	0	1	0	1	0	1	0	A	B	C	D	A	B	C	D
1	0-4	000000	017776	X	X	X	X	X	X	X	X	X	X	X	X	X	X	X	
2	4-8	020000	037776	X	X	X	X	X	X	X	X	X	X	X	X	X	X	X	
3	8-12	040000	057776	X	X	X	X	X	X	X	X	X	X	X	X	X	X	X	
4	12-16	060000	077776	X	X	X	X	X	X	X	X	X	X	X	X	X	X	X	
5	16-20	100000	117776	X	X	X	X	X	X	X	X	X	X	X	X	X	X	X	
6	20-24	120000	137776	X	X	X	X	X	X	X	X	X	X	X	X	X	X	X	
7	24-28	140000	157776	X	X	X	X	X	X	X	X	X	X	X	X	X	X	X	
FROM THIS POINT ON A DEVICE SUCH AS MX11, KS11, OR KT11 IS REQUIRED																			
8	28-32	160000	177776	X	X	X	X	X	X	X	X	X	X	X	X	X	X	X	
9	32-36	200000	217776	X	X	X	X	X	X	X	X	X	X	X	X	X	X	X	
10	36-40	220000	237776	X	X	X	X	X	X	X	X	X	X	X	X	X	X	X	
11	40-44	240000	257776	X	X	X	X	X	X	X	X	X	X	X	X	X	X	X	
12	44-48	260000	277776	X	X	X	X	X	X	X	X	X	X	X	X	X	X	X	
13	48-52	300000	317776	X	X	X	X	X	X	X	X	X	X	X	X	X	X	X	
14	52-56	320000	337776	X	X	X	X	X	X	X	X	X	X	X	X	X	X	X	
15	56-60	340000	357776	X	X	X	X	X	X	X	X	X	X	X	X	X	X	X	
16	60-64	360000	377776	X	X	X	X	X	X	X	X	X	X	X	X	X	X	X	
17	64-68	400000	417776	X	X	X	X	X	X	X	X	X	X	X	X	X	X	X	
18	68-72	420000	437776	X	X	X	X	X	X	X	X	X	X	X	X	X	X	X	
19	72-76	440000	457776	X	X	X	X	X	X	X	X	X	X	X	X	X	X	X	
20	76-80	460000	477776	X	X	X	X	X	X	X	X	X	X	X	X	X	X	X	
21	80-84	500000	517776	X	X	X	X	X	X	X	X	X	X	X	X	X	X	X	
22	84-88	520000	537776	X	X	X	X	X	X	X	X	X	X	X	X	X	X	X	
DE11 REQUIRED FROM THIS POINT IF M11 IS IN USE																			
23	88-92	540000	557776	X	X	X	X	X	X	X	X	X	X	X	X	X	X	X	
24	92-96	560000	577776	X	X	X	X	X	X	X	X	X	X	X	X	X	X	X	
25	96-100	600000	617776	X	X	X	X	X	X	X	X	X	X	X	X	X	X	X	
26	100-104	620000	637776	X	X	X	X	X	X	X	X	X	X	X	X	X	X	X	
27	104-108	640000	657776	X	X	X	X	X	X	X	X	X	X	X	X	X	X	X	
28	108-112	660000	677776	X	X	X	X	X	X	X	X	X	X	X	X	X	X	X	
29	112-116	700000	717776	X	X	X	X	X	X	X	X	X	X	X	X	X	X	X	
30	116-120	720000	737776	X	X	X	X	X	X	X	X	X	X	X	X	X	X	X	
31	120-124	740000	757776	X	X	X	X	X	X	X	X	X	X	X	X	X	X	X	

BUS ADDRESSING BEYOND THIS POINT RESERVED FOR DEVICES

X DENOTES JUMPER INSERTION ON THE BOARD AT THE IDENTIFIED POINT

* INTERLEAVING CAN ONLY BE ACCOMPLISHED WITH 8K SEGMENTS OF MEMORY. THE XXXXX0 AND XXXXX4 ADDRESSES ARE TO BE ASSIGNED TO ODD BANK MEMORIES

digital	FIELD SERVICE TECHNICAL MANUAL				Option or Designator
	12 Bit <input type="checkbox"/>	16 Bit <input checked="" type="checkbox"/>	18 Bit <input type="checkbox"/>	36 Bit <input type="checkbox"/>	MM11
Title DATA ERRORS CAUSED BY DCLO OR INIT ON MM11-K, L, M, S				Tech Tip Number	MM11 #8
All	Processor Applicability	Author A. Verostic/D. Dickhut	Rev g	Cross Reference	
		Approval Art Zins	Date 9/27/72		

A problem exists with the 4K-8K PDP-11 memory (MM11-S, ME11, MM11-L) that appears to be hardware data errors, but disappears if every word in memory is accessed. The problem can appear whenever Initialize or DCLO occurs during a memory cycle. This turns off the X-Y current drivers at the wrong time, leaving some cores in a partially switched state. These half-selected cores contribute large amounts of noise when accessing other words, causing intermittent failures.

DCLO occurring during a memory cycle can be eliminated if the power fail trap is used properly. The power fail trap sequence should turn off any peripheral that might access memory (individually, not by using INIT) and halt the processor before DCLO occurs.

The chances of INIT occurring during a memory cycle will be reduced if software avoids using the RESET Instruction, particularly inside tight loops. The condition of half selected cores can be cured by accessing every word in memory to assure all cores are fully switched. Once this is completed, data may be read and written normally.

Title MM11-K, L, M, and S Field Problem Summary		Tech Tip MM 11 Number TT-9	
All	Processor Applicability	Author D. Dickhut	Rev g
		Approval C. Dewey	Date 11/20/72
		Cross Reference	

This Tech Tip is a summary of field problems and their solutions for the MM11-K, L, M, and S memories which are found in ME11L which uses only MM11-L, 11/05 and 11/10 which use MM11-K (4K), 11/05 only and MM11-L (8K), 11/40 which uses only MM11-L (8K), and 11/45 which uses only MM11-S (8K).

1. Random Memory Locations are Altered During Power Fail

The contents may be altered while running Power Fail Diagnostic or by simply turning the machine on and off. ECO G231-5 solves this problem.

2. Memories do not have to be swapped as a system (all 3 modules)

Each system that is shipped has a serial number stamped on side 2 of each module. This number is the same on all 3 modules and is strictly for in-house test purposes only. The memories can be and should be maintained on a module swap basis instead of a system basis (stack not spared anyway). The system serial number can be used in a case where much swapping has taken place and now the modules are to be put back in their original configuration. By matching the serial number, each system can be reunited and a lot of adjustment time can be saved.

3. What adjustments to make when a module is swapped.

When anyone of the 3 modules that make up the memory system is swapped, the strobe adjustment must be made to ensure system reliability (when the G110 module is swapped, it has the strobe pot but the setting cannot be taken for granted) The procedure to use for strobe adjustment is as follows:

1. If strobe adjustment is too far off, EXAM and DEP may not work. To get strobe in the ballpark, sync on pin CU2 of the G110 model (signal READ H) and Test Point 5 of E05 pin 9 for strobe. Press EXAM rapidly and adjust strobe using pot on G110 for a 250 ns delay from rising edge of READ H to rising edge of strobe. This should allow diagnostics to be read in.
2. Load Worst Case Noise Diagnostic (W.C.N. should be used not a Branch SELF)
3. Load Address 200 and START or Load Address 202 to select the desired bank.
4. Sync on pin CU2 of G110 (signal READ H) while scoping Test Point 5 or E05 pin 9 for strobe and margin strobe by turning pot CW until the diagnostic fails and then CCW until it fails. A complete pass of the diagnostic should be made (within reasonable limits for large core systems) at each high and low end point to ensure that is the true end point. Notice the time from the leading edge of READ H to strobe in each case. The total strobe window should be 40 ns or greater and set strobe in the middle of the high and low points. If the window isn't at least 40 ns, then the entire system should be changed because margin problems can only be dealt with back at Module Repair Depot.

This procedure is graphically illustrated and explained in the ME11L, MM11-S, 11/05, and 11/40 manuals.

digital	FIELD SERVICE TECHNICAL MANUAL				Option or Designator
	12 Bit <input type="checkbox"/>	16 Bit <input checked="" type="checkbox"/>	18 Bit <input type="checkbox"/>	36 Bit <input type="checkbox"/>	MM 11

Title MM11-K, L, M, and S Field Problem Summary (Continued)			Tech Tip MM 11		
			Number TT-9		
All	Processor Applicability		Author D. Dickhut	Rev g	Cross Reference
			Approval C. Dewey	Date 11/20/72	

4. DEC memory stack threshold problem

Some DEC or RCA memory stacks (DEC stack identified by label on side 2; some may have RCA stickers) have a threshold problem and will not exhibit the normal threshold margins. In order to use these previously rejected stacks in production, the sense circuitry on the G110 was modified. In the field, if a memory stack is swapped and it is a DEC stack, the G110 module should be checked to see if ECO #8 is installed. If it isn't and this is a non-Field effect ECO, a G110 module with that ECO should be obtained from the Maynard Module Repair Depot. The new DEC stack may or may not have this problem and probably will operate properly even if it does. However, with large systems or several NPR (DMA) devices, intermittent failures may occur over a long period of time.

Title ECO DOCUMENTATION FOR THE MM11K, MM11L and MM11S MEMORIES				Tech Tip Number MM11 TT-10	
All	Processor Applicability			Author G. Cable	Rev #
				Approval C. Dewey	Date 12/12/72
Cross Reference					

The following Tech Tip will attempt to clarify the confusion regarding the ECO status for the MM11S, MM11K and MM11L memories.

G110 Modules

In the near future there will be two separate types of G110 Modules in the field. The first type of G110 Module is an Etch Revision C Module which already exists in the field. The second type of module will be an Etch Revision E.

It will not be possible to ECO the Etch Revision C Module so that it will be electrically equal to the Etch Revision E Module. For this reason it has become necessary to create two separate sets of engineering drawings to cover the two different modules.

The engineering drawings for the Etch Revision C Module will have a circuit schematic revision of E with one numeric digit following. Each ECO released will increment the numeric digit by one (i.e. E1, E2, E3, and etc.).

The engineering drawings for the Etch Revision E Module will have a circuit schematic revision of an alpha character starting at F and continuing sequentially (i.e. F, H, J, L, and etc.).

Below is a chart that shows the revisions for the two G110 Modules.

G110 Etch Revision C		G110 Etch Revision E	
ECO No.	CS Revision	ECO No.	CS Revision
G110-0001	A	G110-0006	F
G110-0002	B	G110-0011	H
G110-0003	N/A		
G110-0003A	N/A		
G110-0004	D		
G110-0005	E		
G110-0007	E-1		
G110-0008	E-2		
G110-0009	E-3*		
G110-0010	E-4*		
G110-0012	E-5		

*Note: There have been a number of Etch Rev C modules shipped that were marked CS Rev H and J these should have been marked CS Rev E3 and E4 respectively.

digital	FIELD SERVICE TECHNICAL MANUAL				Option or Designator
	12 Bit <input type="checkbox"/>	16 Bit <input checked="" type="checkbox"/>	18 Bit <input type="checkbox"/>	36 Bit <input type="checkbox"/>	MM11

Title ECO DOCUMENTATION FOR THE MM11K, MM11L and MM11S Memories (Continued)				Tech Tip Number MM11-TT-10	
All Processor Applicability		Author G. Cable		Rev g	
x		Approval C. Dewey		Date 12/12/72	
				Cross Reference	

G231 Module

There will also be two separate types of G231 Modules in the field in the near future. For this reason it has become necessary to create two sets of engineering drawings.

The first type of G231 Module will be an Etch Revision of C. All future ECO's for this module will use a circuit schematic revision of E with a numeric digit following. Each ECO released will increment the numeric digit by one (i.e. E4, E5, E6 and etc.).

The second type of G231 Module will be an Etch Revision of E. All future ECO's for this module will use a circuit schematic revision with only an alpha character as a designator starting at CS Revision F and incrementing thru the alphabet (i.e. F, H, J, K, and etc.).

Below is a chart that shows the revisions for the two G231 Modules.

G231 Etch Revision C			G231 Etch Revision E	
ECO No.	CS Revision	Stamped on Module	ECO No.	CS Revision
G231-0001	C	C	G231-0004	F
G231-0002	N/A	N/A		
G231-0003	C-1	E		
G231-0005	1	E-1		
G231-0006	2	E-2		
G231-0007	3	3		
G231-0008	3A	3A		
G231-0009	E4	E4		

Refer to PDP 11/05 Systems Tech Tip #14 for a detailed listing and description of memory ECO's.

A2

Title		New MM11 Option Designations		Tech Tip Number		MM11-TT-11	
All	Processor Applicability			Author	Rev	Cross Reference	
				D. Dickhut	g		
				Approval	Date		
				C. Dewey	1/19/73		

This tech tip is to define the new variations of memories that are in existence and how they differ from the present MM11-L and S memories. The MM11-L and S are defined again for reference.

MM11-L (8K X 16, 900 ns)

It consists of a G110, G231 and H214 and is used on 11/05, 11/10, ME11-L and 11/40.

MM11-S (8K X 16, 900 ns)

This consists of a G110, G231, H214, and a system unit. It is used on 11/35, 11/40 to 11/45.

MM11-LP (8K X 18, memory parity)

This consists of a G109, G231 and H215 and is designed for memory parity. It plugs into a MF11-LP.

MF11-LP (Parity Option)

This is a memory parity option that consists of a nine slot backplane, one MM11-LP and one M7259 double height double width memory parity controller. The backplane can accommodate three MM11-LP's. This option is used on 11/35, 11/40 and 11/45.

MF11-L

This is a memory option that consists of a nine slot backplane and one MM11-L. It can accommodate three MM11-L and is used on 11/35, 11/40 and 11/45.

MB11-S (8K X 16)

This is a special 8K X 16 memory with a 850 ns cycle time and consists of a G110-YA, G231, and H214-YA. This memory is used only on 11/45 and exists in very limited quantities.

G109-YA (for reference only)

Module used only on PDP15 memories.

It is important to remember that the modules mentioned in the above definitions are not interchangeable with a similar looking type in another category. For example a G109 is not interchangeable with a G110 nor is a G110 interchangeable with a G110-YA. When a memory module is replaced or swapped, it should only be replaced with the exact same module type, even though another type may appear to work.

digital	FIELD SERVICE TECHNICAL MANUAL				Option or Designator
	12 Bit <input type="checkbox"/>	16 Bit <input checked="" type="checkbox"/>	18 Bit <input type="checkbox"/>	36 Bit <input type="checkbox"/>	MM 11

Title MM11- E and F in BALL-B/D/F Mounting Boxes				Tech Tip MM11-TT-12 Number	
All	Processor Applicability		Author B. Dimbat	Rev 0	Cross Reference
			Approval C. Dewey	Date 3/14/73	

MM11E and MM11F memories cannot be installed in the 11/40 box. They cannot be installed in BALL-B/D/F boxes. They can be used on the 11/40 system but only if they are installed in an 11/20 type box (BALL-ES), which has its own power supply.

MM11E/F's, installed in an 11/40 box, will lose data during the power down sequence.

Ca

Title MM11 L, S, K Memory Address Decode				Tech Tip Number MM-TT-13	
All	Processor Applicability		Author John Alston	Rev 0	Cross Reference
			Approval B. Dimbat	Date 6/1/73	

The diagram and tables supplied here are to aid F/S men when they are troubleshooting MM11L, S & K memories by relating the drive signals on the G231 with the addresses that generate them.

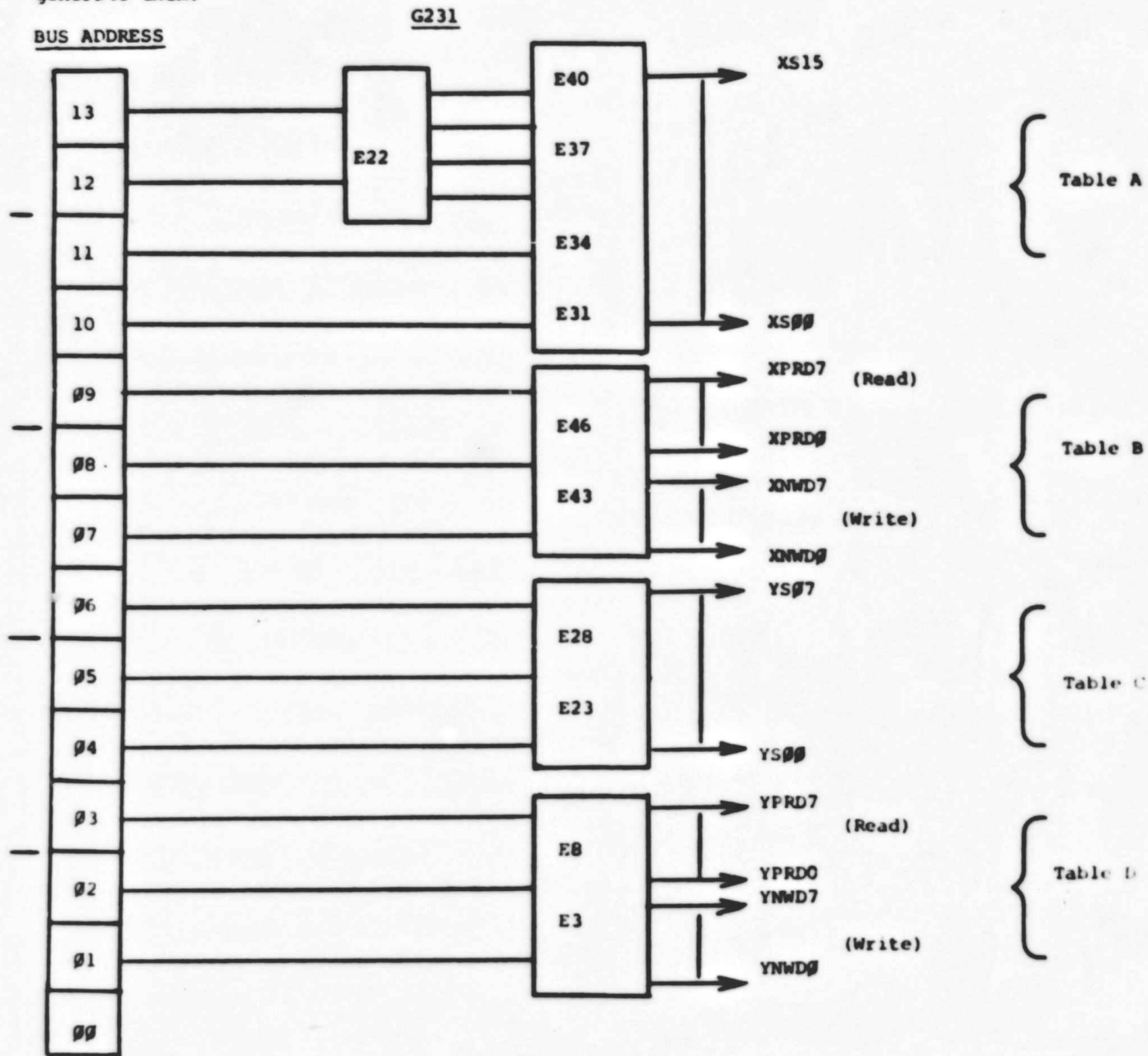

digital	FIELD SERVICE TECHNICAL MANUAL				Option or Designator
	12 Bit <input type="checkbox"/>	16 Bit <input checked="" type="checkbox"/>	18 Bit <input type="checkbox"/>	36 Bit <input type="checkbox"/>	MM11

Title MM11 L, S, K Memory Address Decode				Tech Tip Number MM11-TT-13	
All	Processor Applicability		Author J. Alston	Rev g	
			Approval B. Dimbat	Date 6/1/73	
Cross Reference					

	A11=1, A10=1	A11=1, A10=0	A11=0, A10=1	A10=0, A11=0
A13=1	XS15	XS14	XS13	XS12
A12=1	E40			
A13=1	XS11	XS10	XS09	XS08
A12=0	E37			
A13=0	XS07	XS06	XS05	XS04
A12=1	E34			
A13=0	XS03	XS02	XS01	XS00
A12=0	E31			

TABLE A

		A08=1, A07=1	A08=1, A07=0	A08=0, A07=1	A08=0, A07=0
Read Cyc.	A09=1	XPRD7	XPRD6	XPRD5	XPRD4
		E46			
Write Cyc.	A09=0	XPRD3	XPRD2	XPRD1	XPRD0
		E43			
Read Cyc.	A09=1	XNWD7	XNWD6	XNWD5	XNWD4
		E46			
Write Cyc.	A09=0	XNWD3	XNWD2	XNWD1	XNWD0
		E43			

TABLE B

E2

Title MM11, L, S, K Memory Address Decode			Tech Tip Number MM-TT-13	
All	Processor Applicability		Author J. Alston	Rev 0
			Approval B. Dimbat	Date 6/1/73
Cross Reference				

TABLE C

	A05=1, A04=1	A05=1, A04=0	A05=0, A04=1	A05=0, A04=0
A06=1	YS07	YS06	YS05	YS04
	_____ E28 _____			
A06=0	YS03	YS02	YS01	YS00
	_____ E23 _____			

TABLE D

		A02=1, A01=1	A02=1, A01=0	A02=0, A01=1	A02=0, A01=0
Read	A03=1	YPRD7	YPRD6	YPRD5	YPRD4
		_____ E8 _____			
Cyc.	A03=0	YPRD3	YPRD2	YPRD1	YPRD0
		_____ E3 _____			
Write	A03=1	YNWD7	YNWD6	YNWD5	YNWD4
		_____ E8 _____			
Cyc.	A03=0	YNWD3	YNWD2	YNWD1	YNWD0
		_____ E3 _____			

digital	FIELD SERVICE TECHNICAL MANUAL				Option or Designator
	12 Bit <input type="checkbox"/>	16 Bit <input checked="" type="checkbox"/>	18 Bit <input type="checkbox"/>	36 Bit <input type="checkbox"/>	M11 MEMORY OPTIONS

Title M11-D/DP Memory Backplane				Tech Tip Number M11-TT-14	
All	Processor Applicability		Author William Aupperlee	Rev g	Cross Reference
			Approval William Dinbar	Date 8-5-76	

The M11-D/DP Core Memory Manual states that the G652 (mother board for the M11-D/DP) is inserted into a "Unibus Backplane". To eliminate any confusion, the "Unibus Backplane" is the modified backplanes DD11-C, D and P used on 11/04, 11/34 systems. Other Unibus Backplanes, such as 11/05, 11/35 and DD-11B expansion backplanes are not compatible with these new memory boards.

Title M11-U/UP MEMORIES FAILING HIGH CURRENT MARGINS				Tech Tip Number M11-TT-15	
All	Processor Applicability		Author Jim Holderby	Rev g	Cross Reference
			Approval Lee Mickle	Date 9-13-76	

Many reports have been received from the field concerning memories failing high current margins and module set incompatibility (i.e. unable to swap modules). Investigation has shown that the inhibit margins are not properly centered, which could cause marginal operation of the memory under conditions of high drive currents. An ECO (G235-0009) was generated to correct this problem.

Therefore, if a memory exhibits these symptoms, do a visual inspection of the G235 for the ECO. A quick check for the ECO is:

1. Place G235 component side up and fingers toward you.
2. Look at right hand side of module in large etch area (see drawing).
3. If resistor R103 (75Ω 1W) which is across bottom of large etch is not in, ECO has not been installed.

This ECO should be installed before attempting massive module swap or option swap.

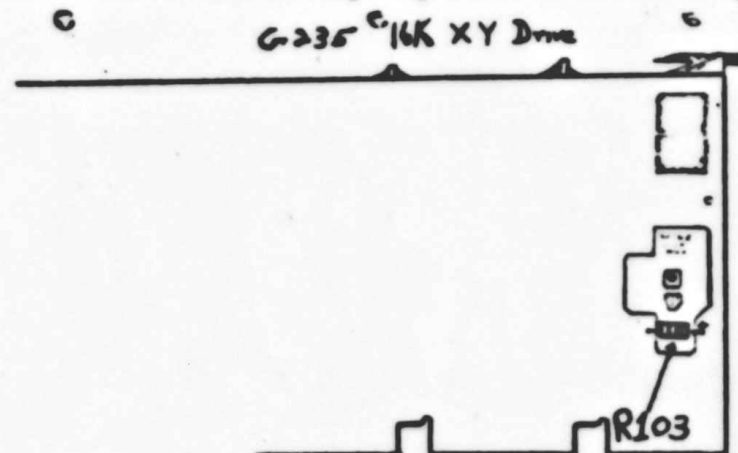

Title MM11-U/UP INSTALLATION					Tech Tip Number MM11 TT-16	
Processor Applicability			Author Jim Holderby		Rev g	
All			Approval Lee Mickle (jm)		Date 12-14-76	
X					Cross Reference	

There is a problem if more than 64K of MM11-U memory is installed in the new type expansion box (BALLF) with power distribution harness 7009566. When the second H754 power supply is installed, the jumpers must be removed from the power harness. The jumpers connect P2 pin 3 to P5 pin 3 and P2 pin 14 to P5 pin 14. If these jumpers are not removed, the two(2) H754 power supplies are connected in parallel and it is possible to damage one or both regulators. The reason the jumpers are there is to allow us to install the memory backplane anywhere in the cabinet.

This information is not in the installation procedure; however, it can be found in the PDP 11/45 and 11/50 System Maintenance Manual (DEC-11-H45SM-D-D) Figure 8-5, power distribution schematic.

Title MM11-E TROUBLE SHOOTING AID					Tech Tip Number MM11-TT-17	
Author MICHAEL BABCOCK			F.S. Office PITTSBURGH, PA		Date 7 JUNE 77	
Processor Applicability			Mgr./Sup.		Date	
All			Approval: JIM HOLDERBY		Date 16 JUN 77	
11					Revision 0	
					Cross Reference	

THE FOLLOWING IS INTENDED AS A TROUBLE SHOOTING AID FOR THE MM11-E MEMORY

ADDRESS															
MEMORY SELECT			X SWITCH READ AND WRITE			X DRIVER READ AND WRITE			Y SWITCH READ AND WRITE			Y DRIVER READ AND WRITE			BYTE SELECTION
15	14	13	12	11	10	9	8	7	6	5	4	3	2	1	
			$\phi_{(0)} = X50$			$\phi_{(0)} = XD0$			$\phi_{(0)} = Y50$			$\phi_{(0)} = YD0$			
			$1_{(0)} = X51$			$1_{(0)} = XD1$			$1_{(0)} = Y51$			$1_{(0)} = YD1$			
			$2_{(0)} = X52$			$2_{(0)} = XD2$			$2_{(0)} = Y52$			$2_{(0)} = YD2$			
			$3_{(0)} = X53$			$3_{(0)} = XD3$			$3_{(0)} = Y53$			$3_{(0)} = YD3$			
			$4_{(0)} = X54$			$4_{(0)} = XD4$			$4_{(0)} = Y54$			$4_{(0)} = YD4$			
			$5_{(0)} = X55$			$5_{(0)} = XD5$			$5_{(0)} = Y55$			$5_{(0)} = YD5$			
			$6_{(0)} = X56$			$6_{(0)} = XD6$			$6_{(0)} = Y56$			$6_{(0)} = YD6$			
			$7_{(0)} = X57$			$7_{(0)} = XD7$			$7_{(0)} = Y57$			$7_{(0)} = YD7$			

X AND Y DRIVER SIGNALS ARE POSITIVE FOR READ; NEGATIVE FOR WRITE
(1.e. YPD ϕ FOR READ; YND ϕ FOR WRITE)

X AND Y SWITCH SIGNALS ARE NEGATIVE FOR READ; POSITIVE FOR WRITE
(1.e. XNS ϕ FOR READ; XPS ϕ FOR WRITE)

YD ϕ - YD3 ON G226 SLOT C03
YD4 - YD7 ON G226 SLOT F03
YS ϕ - YS3 ON G226 SLOT C03
YS4 - YS7 ON G226 SLOT F03

XD ϕ - XD3 ON G226 SLOT C02
XD4 - XD7 ON G226 SLOT F02
XS ϕ - XS3 ON G226 SLOT C02
XS4 - XS7 ON G226 SLOT F02

digital	FIELD SERVICE TECHNICAL MANUAL				Option or Designator MM11
	12 Bit <input type="checkbox"/>	16 Bit <input checked="" type="checkbox"/>	18 Bit <input type="checkbox"/>	36 Bit <input type="checkbox"/>	MEMORY OPTION

Title MM11-E TROUBLE SHOOTING AID (CONT)			Tech Tip Number MM11-TT-17		
Author MICHAEL BABCOCK		F.S. Office PITTSBURGH, Pa	Date 6/17/77	Revision 0	
Processor Applicability		Mgr./Sup.	Date	Cross Reference	
All 11		Approval: JIM HOLDERBY Date 6/17/77			

LOSS OF A BYTE - TROUBLE WITH BIT 0
LOSS OF 1 (OCTAL) IN EVERY 20 (OCTAL) LOCATIONS - BAD Y DRIVER
LOSS OF 20 (OCTAL) LOCATIONS IN EVERY 200 (OCTAL) LOCATIONS - BAD Y SWITCH
LOSS OF 200 (OCTAL) LOCATIONS IN EVERY 2,000 (OCTAL) LOCATIONS - BAD X DRIVER
LOSS OF 2000 (OCTAL) LOCATIONS IN EVERY 20000 (4K) (OCTAL) LOCATIONS - BAD X SWITCH

ANY DATA BIT DROPAGE OR PICKUP IS PROBABLY CAUSED BY THE G102'S

DATA BITS 0-3	G102 SLOT D03
DATA BITS 4-7	G102 SLOT D02
DATA BITS 8-11	G102 SLOT E03
DATA BITS 12-15	G102 SLOT E02

ADDRESS BIT 0 - BYTE SELECT DURING DATOB

ADDRESS BITS 1-3			READ DRIVER	WRITE DRIVER	
3	2	1			
0	0	0	YPD0	YND0	
0	0	1	YPD1	YND1	SWITCH/DECODER A
0	1	0	YPD2	YND2	G226 SLOT C03
0	1	1	YPD3	YND3	
1	0	0	YPD4	YND4	
1	0	1	YPD5	YND5	SWITCH/DECODER B
1	1	0	YPD6	YND6	G226 SLOT F03
1	1	1	YPD7	YND7	

ADDRESS BITS 4-6					
6	5	4			
0	0	0	YNS0	YPS0	
0	0	1	YNS1	YPS1	SWITCH/DECODER C
0	1	0	YNS2	YPS2	G226 SLOT C03
0	1	1	YNS3	YPS3	
1	0	0	YNS4	YPS4	
1	0	1	YNS5	YPS5	SWITCH/DECODER D
1	1	0	YNS6	YPS6	G226 SLOT F03
1	1	1	YNS7	YPS7	

DEC CONFIDENTIAL
This document is proprietary to Digital Equipment Corporation and is intended for use by its Field Service Organization only.
For information on writing or approving a Tech Tip, see Administration Tech Tip Number 2.

Page 19	Page Revision 0	Publication Date JUNE 1977
---------	-----------------	----------------------------

PRINTED IN U.S.A.

Title MM11-E TROUBLE SHOOTING AID (CONT)				Tech Tip Number MM11-TT-17	
Author MICHAEL BABCOCK		F.S. Office PITTS., PA		Date 6/17/77	Revision 0
Processor Applicability		Mgr./Sup.		Date	Cross Reference
All	11	Approval: JIM HOLDERBY		Date 6/17/77	

ADDRESS BITS 7-9

9	8	7			
0	0	0	XPD0	XND0	
0	0	1	XPD1	XND1	SWITCH/DECODER A
0	1	0	XPD2	XND2	G226 SLOT C02
0	1	1	XPD3	XND3	
1	0	0	XPD4	XND4	
1	0	1	XPD5	XND5	SWITCH/DECODER B
1	1	0	XPD6	XND6	G226 SLOT F02
1	1	1	XPD7	XND7	

ADDRESS BITS 10-12

12	11	10			
0	0	0	XNS0	XPS0	
0	0	1	XNS1	XPS1	SWITCH/DECODER C
0	1	0	XNS2	XPS2	G226 SLOT C02
0	1	1	XNS3	XPS3	
1	0	0	XNS4	XPS4	
1	0	1	XNS5	XPS5	SWITCH/DECODER D
1	1	0	XNS6	XPS6	G226 SLOT F02
1	1	1	XNS7	XPS7	

Title M7850 S SYN DLY ADJUSTMENT (MM11-CP, MM11-DP)				Tech Tip Number MM11-TT-18	
Author JIM HOLDERBY		F.S. Office MAYNARD		Date 9-23-77	Revision 0
Processor Applicability		Mgr./Sup. LEE MICKLE		Date 9-23-77	Cross Reference
All		Approval: LEE MICKLE		Date 9-23-77	M7850-TT-1

THIS TECH TIP APPLIES TO MM11-CP AND MM11-DD. CROSS REFERENCE M7850.

MM11-E

MM11-E/F PARTS BREAKDOWN

7006405	- Logic Frame
7006468	- MM11-E Wired assembly
70007263	- MM11-F Wired assembly
G102	- Sense Inhibit Card
G103	- Memory Levels & Gates
G225	- X-Y Current Generator
G226	- X-Y Current Generator
H207	- 4K 16 Bit Core Memory Stack
M109	- Device Select
M729	- MM11-E Control Logic
M1091	- Device Select
M7290	- Control Logic & Timing
MM11-E	- 4K Single Memory Unit
MM11-EX	- 4K Interleaved
MM11-F	- 4K Single Memory Unit
MM11-FP	- Single Parity Memory Unit
MM11-FX	- Interleaved Memory (jumpers)

DOL

ONLY FCO'S WRITTEN TO THE "MM11-E" OPTION ARE DOCUMENTED ON THIS FICHE. FCO'S FOR THE G102, G103, G225 ARE DOCUMENTED IN THE MODULE ASSEMBLY (BLUE) SECTION OF THE LIBRARY.

THIS DOCUMENT WAS NOT PRODUCED FOR MICROFICHE; THEREFORE, ONLY PARTS OF IT ARE READABLE.

Engineering Change Order Log

DEC-O-LOG

ECO SYNOPSIS pages are updated and published continuously in conjunction with the issuance of ENGINEERING CHANGE ORDERS for all DEC products and are available upon subscription from:

DIGITAL EQUIPMENT CORPORATION
FIELD SERVICE INFORMATION CENTER
MAYNARD, MASSACHUSETTS 01754

digital EQUIPMENT CORPORATION
MAYNARD, MASSACHUSETTS

ECO SYNOPSIS FOR LOGIC OR OPTION

PDP-11 MEMORY **MM11-E**

PRODUCT LINE	PUBLICATION DATE OF THIS SYNOPSIS PAGE	PAGE REVISION
PDP-11	JULY 1976	8

ECO NO.	LOGIC OR OPTION SERIAL NO.'S AFFECTED	FIELD CODE	SYNOPSIS
MM11-E 00001	>MM11-E	M	JAN 70 - CHANGES STACK HINGE TOLERANCE AND ADDS A FLATNESS SPECIFICATION.
MM11-E 00002	MM11-E 110-120*	D	JAN 70 - MAKES CORRECTIONS TO THE WIRE LIST.
MM11-E 00003	MM11-E 110-120*	D	JAN 70 - ADDS CURRENT LOOPS FOR X AND Y CURRENT MEASUREMENTS AND SCOPING. UPDATES THE LIST OF MANUALLY INSTALLED WIRING.
MM11-E 00004	>MM11-E	D	JAN 70 - UPDATES THE MM11-E PRINT SET.
MM11-E 00005	N.A.	D	JAN 70 - CORRECTS A DRAWING WHICH WAS DRAWN IN REVERSE. ADDS CLARIFICATION NOTES.
MM11-E 00006	MM11-E 110-239*	D	FEB 70 - ADDS TWO WIRES WHICH WERE PREVIOUSLY OMITTED FROM THE WIRE LIST.
MM11-E 00007	>MM11E	M	FEB 70 - CHANGES THE SPECIFICATION FOR THE MEMORY HINGE. SPECIFIES THE USE OF SELF EXTINGUISHING PLASTIC FOR MM11-E FABRICATION.
M729 00001	ALL M729	D	MAR 70 - REVISES SEVERAL DESIGN CONSIDERATIONS; CHANGES THE ETCH LAYOUT AND SEVERAL COMPONENTS. MODULE STATUS - UNRELEASED. M729 CIRCUIT SCHEMATIC REVISION A ETCHED BOARD REVISION B
G226 00003	>G226	D	MAR 70 - ADDS DIODES TO CLAMP OUTPUT VOLTAGE SPIKES WHICH COULD EXCEED THE TRANSISTOR BREAKDOWN RATING. MODULE STATUS - UNRELEASED. G226 CIRCUIT SCHEMATIC REVISION C

<p>LEGEND</p> <p>FIELD CODE</p> <p>F - Field action may be required</p> <p>D - Design ECO</p> <p>P - Print or Wire List change</p> <p>M - Mechanical ECO</p> <p>SYMBOL</p> <p>> - ECO applicable to future production</p> <p>ECO CHARGES</p> <p>Changes are coded within the synopsis (18A **8Y **18Z)</p> <p>8A - Charge for Scribe and updated prints only</p> <p>8Y - Charge for necessary parts only</p> <p>8Z - Charge for on site labor only (installation by DEC)</p> <p>NOTE: Charges are additive (8A+8Y+8Z) - Total on one charge for ECO installation by DEC.</p>	<p>MASTER DRAWING LIST REVISIONS</p> <table border="1"> <tr> <th>REV</th> <th>ECO NUMBER</th> <th>REV</th> <th>ECO NUMBER</th> </tr> <tr> <td>A</td> <td>MM11E-00002</td> <td></td> <td></td> </tr> <tr> <td>B</td> <td>MM11E-00003</td> <td></td> <td></td> </tr> <tr> <td>C</td> <td>MM11E-00004</td> <td></td> <td></td> </tr> <tr> <td>D</td> <td>MM11E-00005</td> <td></td> <td></td> </tr> <tr> <td>E</td> <td>MM11E-00006</td> <td></td> <td></td> </tr> <tr> <td>F</td> <td>PDP11-00004</td> <td></td> <td></td> </tr> </table>		REV	ECO NUMBER	REV	ECO NUMBER	A	MM11E-00002			B	MM11E-00003			C	MM11E-00004			D	MM11E-00005			E	MM11E-00006			F	PDP11-00004			<p>WIRE LIST REVISIONS</p> <table border="1"> <tr> <th>REV</th> <th>ECO NUMBER</th> <th>REV</th> <th>ECO NUMBER</th> </tr> <tr> <td>A</td> <td>MM11E-22422</td> <td></td> <td></td> </tr> <tr> <td>B</td> <td>MM11E-22226</td> <td></td> <td></td> </tr> </table>		REV	ECO NUMBER	REV	ECO NUMBER	A	MM11E-22422			B	MM11E-22226		
	REV	ECO NUMBER	REV	ECO NUMBER																																								
A	MM11E-00002																																											
B	MM11E-00003																																											
C	MM11E-00004																																											
D	MM11E-00005																																											
E	MM11E-00006																																											
F	PDP11-00004																																											
REV	ECO NUMBER	REV	ECO NUMBER																																									
A	MM11E-22422																																											
B	MM11E-22226																																											

ECO NO.	LOGIC OR OPTION SERIAL NO.'S AFFECTED	FIELD CODE	SYNOPSIS
G102 00002	>PDP-11	F	MAR 70 - REPLACES THE 8881 IC WITH A 74011 TO INCREASE SPEED. THIS MODULE CANNOT BE REWORKED IN THE FIELD. (ERROR CORRECTED BY ECO G102-00003) G102 CIRCUIT SCHEMATIC REVISION B ETCHED BOARD REVISION D
G103 00002	ALL PDP-11	S	MAR 70 - REPLACES SN7410N IC WITH SN7410N TO INCREASE SYSTEM SPEED. THE MODULE CANNOT BE REWORKED IN THE FIELD. G103 CIRCUIT SCHEMATIC REVISION B
G102 00003	>PDP-11	F	APR 70 - CORRECTS AN ERROR IN ECO G102-00002; CHANGES 100 OHM RESISTORS TO 75 OHMS. G102 CIRCUIT SCHEMATIC REVISION B ETCHED BOARD REVISION D
MM11-E 20008	>MM11-E	P	APR 70 - CORRECTS DIMENSIONS ON THE ETCHED BOARD DRAWING TO MEET STANDARDS.
MM11-E 20009	N.A.	P	APR 70 - CHANGES WIRING AND TURING REFERENCES ON THE PARTS LIST.
G103 00004	ALL PDP-11	S	APR 70 - CHANGES N17 FROM A 100 OHM THERMISTOR TO A 500 OHM THERMISTOR. G103 CIRCUIT SCHEMATIC REVISION C
G616 00001	N.A.	D	APR 70 - DELETES THE MODULE HANDLE FROM THE G616 PARTS LIST AND ADDS IT TO THE MEMORY STACK PARTS LIST. G616 CIRCUIT SCHEMATIC REVISION B
G616 00002	>G616	D	MAY 70 - INTERCHANGES THE POSITIONS OF THERMISTOR N11 AND RESISTOR N1. G616 CIRCUIT SCHEMATIC REVISION C
MM11-E 02210	N.A.	P	MAY 70 - ADDS A MODULE CLIP HOLDER PART NUMBER AND ITS DESCRIPTION TO THE PARTS LIST.
MM11-E 02011	>MM11-E	P	MAY 70 - ADDS MM11-E ALIGNMENT PROCEDURE TO THE PRINT SET.
MM11-E 02012	>MM11-E	D	MAY 70 - CHANGES A HOLE SIZE AND ADDS TWO OTHERS FOR THE G616.

<p>LEGEND</p> <p>FIELD CODE</p> <p>F - Field action may be required</p> <p>D - Design ECO</p> <p>P - Print or Wire List change</p> <p>M - Mechanical ECO</p> <p>SYMBOL</p> <p>> - ECO applicable to future production</p> <p>ECO CHARGES</p> <p>Changes are coded within the synopsis (18A **8Y **18Z)</p> <p>8A - Charge for Scribe and updated prints only</p> <p>8Y - Charge for necessary parts only</p> <p>8Z - Charge for on site labor only (installation by DEC)</p> <p>NOTE: Charges are additive (8A+8Y+8Z) - Total on one charge for ECO installation by DEC.</p>	<p>MASTER DRAWING LIST REVISIONS</p> <table border="1"> <tr> <th>REV</th> <th>ECO NUMBER</th> <th>REV</th> <th>ECO NUMBER</th> </tr> <tr> <td>M</td> <td>MM11E-00009</td> <td></td> <td></td> </tr> <tr> <td>J</td> <td>MM11E-00010</td> <td></td> <td></td> </tr> <tr> <td>K</td> <td>MM11E-00011</td> <td></td> <td></td> </tr> </table>		REV	ECO NUMBER	REV	ECO NUMBER	M	MM11E-00009			J	MM11E-00010			K	MM11E-00011			<p>WIRE LIST REVISIONS</p> <table border="1"> <tr> <th>REV</th> <th>ECO NUMBER</th> <th>REV</th> <th>ECO NUMBER</th> </tr> <tr> <td></td> <td></td> <td></td> <td></td> </tr> <tr> <td></td> <td></td> <td></td> <td></td> </tr> </table>		REV	ECO NUMBER	REV	ECO NUMBER								
	REV	ECO NUMBER	REV	ECO NUMBER																												
M	MM11E-00009																															
J	MM11E-00010																															
K	MM11E-00011																															
REV	ECO NUMBER	REV	ECO NUMBER																													

03

THIS DOCUMENT WAS NOT PRODUCED FOR MICROFICHE; THEREFORE, ONLY PARTS OF IT ARE READABLE.

Engineering Change Order Log

ECO SYNOPSIS pages are updated and published continuously in conjunction with the issuance of **ENGINEERING CHANGE ORDERS** for all DEC products and are available upon subscription from:

DIGITAL EQUIPMENT CORPORATION
FIELD SERVICE INFORMATION CENTER
MAYNARD, MASSACHUSETTS 01754

digital EQUIPMENT CORPORATION
MAYNARD, MASSACHUSETTS

ECO SYNOPSIS FOR LOGIC OR OPTION

PDP-11 MEMORY **MM11-E**

PRODUCT LINE	PUBLICATION DATE OF THIS SYNOPSIS PAGE	PAGE REVISION
PDP-11	APRIL 1976	4

ECO NO	LOGIC OR OPTION SERIAL NO'S AFFECTED	FIELD CODE	SYNOPSIS
MM11-E L0017	MM11-E AS REQUIRED	F	JAN 71 - CORRECTS THE TEST PROCEDURE TO SPECIFY CHANGING THE SENSE SKIPPING FROM 210 NSFC TO 220 NSFC TO IMPROVE MEMORY PERFORMANCE. ECO MM11-E0020 SUPERSEDES THIS 220 NSFC SENSE SKIPPING REVISION TO 210 NSFC. SOMEONE'S CHANGE WAS FOR HIGH FOR UPPER PERFORMANCE AND ADJUSTING THE REFERENCE VOLTAGE. CHANGED THE JUNE 71. UPDATES THE BLOCK SCHEMATIC TO REFLECT CHANGES MADE TO THE 210 CIRCUIT SCHEMATIC. UPDATES TITING AND FLOW DIAGRAMS.
MM11-E L0018	MM11-E	F	JAN 71 - OPENS SCOTTING OF THE 208 PIN HOOK ENDS TO ELIMINATE THEIR REMOVAL. USE 208 PIN SIZE CARDS ARE INSTALLED AND REQUIRED.
MM11-E L0019	MM11-E	F	MAR 71 - UPDATES DOCUMENTATION TO INCLUDE THE MM11E MODULE. UPDATES PRINTS TO INCLUDE INSTRUCTIONS FOR INTERLEAVING MODULES.
MM11-E L0022	MM11-E WITH ECO MM11-E0017	F	MAR 71 - THIS ECO RESCINDS THE SENSE SKIPPING SPECIFICATION OF ECO MM11-E0017. CORRECTS THE TEST PROCEDURE TO SPECIFY SKIPPING THE SENSE AT 210 NSFC. SKIPPING IT AT 220 NSFC AS SUGGESTED IN ECO MM11-E0017 IS TOO LATE FOR UPPER PERFORMANCE.
			<p>MM11E-0001 CODE: P ML: V MAY 71 - PROBLEM Packaging instructions for the PDP-11 memory stack are not included in the print set. CORRECTION: Add packaging instructions to MM11E drawing index list. In plant effectively. Documentation change only.</p> <p>MM11E-0002 CODE: DF ML: W MAR 72 - PROBLEM Under some conditions when other options are placed along side an MM11E, they fail to operate correctly. CORRECTION: Install a module protection plate. In plant effectively. Retrofit all MM11E's as required. Field effectivity: All MM11E as required. Time To Install And Test 10 Hour. Kit Contents: PDP Prints And Parts.</p> <p>MM11E-023 CODE: P ML: V APR 72 - CORRECTION Update test procedure. In plant effectively. Documentation change only.</p> <p>MM11E-0004 CODE: F ML: AA WL: E MAY 72 - PROBLEM 1: Stray signals and TISH have too much noise on them. CORRECTION 1: Install twisted pair wiring for these signals. PROBLEM 2: READ B signal has too many leads on it. CORRECTION 2: Develop another READ B signal to share the load. In plant effectively. Retrofit immediately. Field effectivity: Retrofit all MM11E. CN revision E is created. Time To Install And Test 10 Hour. Kit Contents: PDP Prints only.</p>

R624

ECO NO	LOGIC OR OPTION SERIAL NO'S AFFECTED	FIELD CODE	SYNOPSIS
			REFERENCE ECO G102-H0024
G103 L0005	ALL MM10 >MM11-E	F	JUN 70 - CHANGES CIRCUITRY TO PROVIDE 16-PIN INSTEAD OF 14-PIN FOR THE SENSE AMPLIFIERS. ADDS A HEAT SINK TO 14 TO PROVIDE ADEQUATE HEAT DISSIPATION. BOTH OF THESE CHANGES ARE ORDERED FOR IMMEDIATE RETROFIT IN THE MM10 BUT ARE TO BE PHASED IN BY THE MM11-E. CHANGES CIRCUITRY TO SPEED UP TURN-OFF TIME FOR THE STACK DISCHARGE CIRCUITS. THIS CHANGE IS TO BE PHASED IN ON BOTH THE MM10 AND MM11-E. THE MODULE CAN BE REWORKED IN THE FIELD.
G225 00003	ALL MM11-E	F	JUL 70 - REDUCES THE VALUE OF RESISTOR R22 TO 2.2K TO SPEED UP STABILIZATION OF THE 47V CURRENT REFERENCE VOLTAGE. SOLVES THE PROBLEM OF LOSS OF MEMORY DATA DURING POWER UP OR POWER DOWN.
MM11-E L0013	MM11-E	F	JUL 70 - SPECIFIES A REWORKING OF THE MODULE HOLDERS.
MM11-E L0014	MM11-E 122-953>	F	AUG 70 - DELETES CONFLICTING REFERENCES TO THE IC'S OF THE G102 FROM THE MM11E-04 LOGIC PRINT.
MM11-E L0015	MM11-E 101-953>	F	SEP 70 - CONNECTS THE SIGNAL BUS TWO LEADS FROM THE POWER BUS TO THE UNIBUS. THESE CHANGES ENSURE PROPER OPERATION OF THE POWER FAIL OPTION IN MULTIPLE MCR SYSTEMS. THIS ECO MUST BE INSTALLED IN CONJUNCTION WITH ECO'S MM11-E0001, MM11-E0002, AND 5400475. APPROX AND IS APPLICABLE TO ALL MULTIPLE MCR SYSTEMS.
MM11-E L0016	ALL MM11-E SHIPPED JULY- DEC-1970	F	AUG 70 - PROVIDES A COPY OF THE 3400 WIRE TRAIL AND INSTRUCTIONS FOR CORRECTING IMPROPERLY WIRING UNITS WHICH WERE SHIPPED BETWEEN JULY AND DECEMBER OF 1970. SYMPTOMS OF THIS MEMORY WIRING PROBLEM INCLUDE DATA ERRORS, LOW MEMORY MARGINS, AND NON-INTERCHANGEABILITY OF G102 MODULES.

LEGEND

FIELD CODE

- F = Field action may be required
- D = Design ECO
- P = Print or flow list change
- M = Maintenance ECO

SYMBOL

- > = ECO applicable to future production

ECO CHARGES

Charges are added with the symbols: *\$* **\$* ***\$*

- \$* = Charge for extra and updated prints only
- \$** = Charge for necessary parts only
- \$\$\$ = Charge for an one other \$** modification by DEC

NOTE: Charges are added (\$*-\$**-\$*** = \$\$\$) on one charge for ECO modification by DEC.

MASTER DRAWING LIST REVISIONS

REV	ECO NUMBER	REV	ECO NUMBER
1	MM11E-P0013		
2	MM11E-0001A		
3	MM11E-0001B		
4	MM11E-C0016		

WIRE LIST REVISIONS

REV	ECO NUMBER	REV	ECO NUMBER
1	MM11E-0001B		

JUN 7 1976

LEGEND

FIELD CODE

- F = Field action may be required
- D = Design ECO
- P = Print or flow list change
- M = Maintenance ECO

SYMBOL

- > = ECO applicable to future production

ECO CHARGES

Charges are added with the symbols: *\$* **\$* ***\$*

- \$* = Charge for extra and updated prints only
- \$** = Charge for necessary parts only
- \$\$\$ = Charge for an one other \$** modification by DEC

NOTE: Charges are added (\$*-\$**-\$*** = \$\$\$) on one charge for ECO modification by DEC.

MASTER DRAWING LIST REVISIONS

REV	ECO NUMBER	REV	ECO NUMBER
4	MM11E-C0017		
5	MM11E-0001B		
1	MM11E-0001B		
11	MM11E-C0020		

WIRE LIST REVISIONS

REV	ECO NUMBER	REV	ECO NUMBER
11	MM11E-L0017		

JUN 7 1976

E3

FCCO'S

DWG LOC.
B-6

B-4

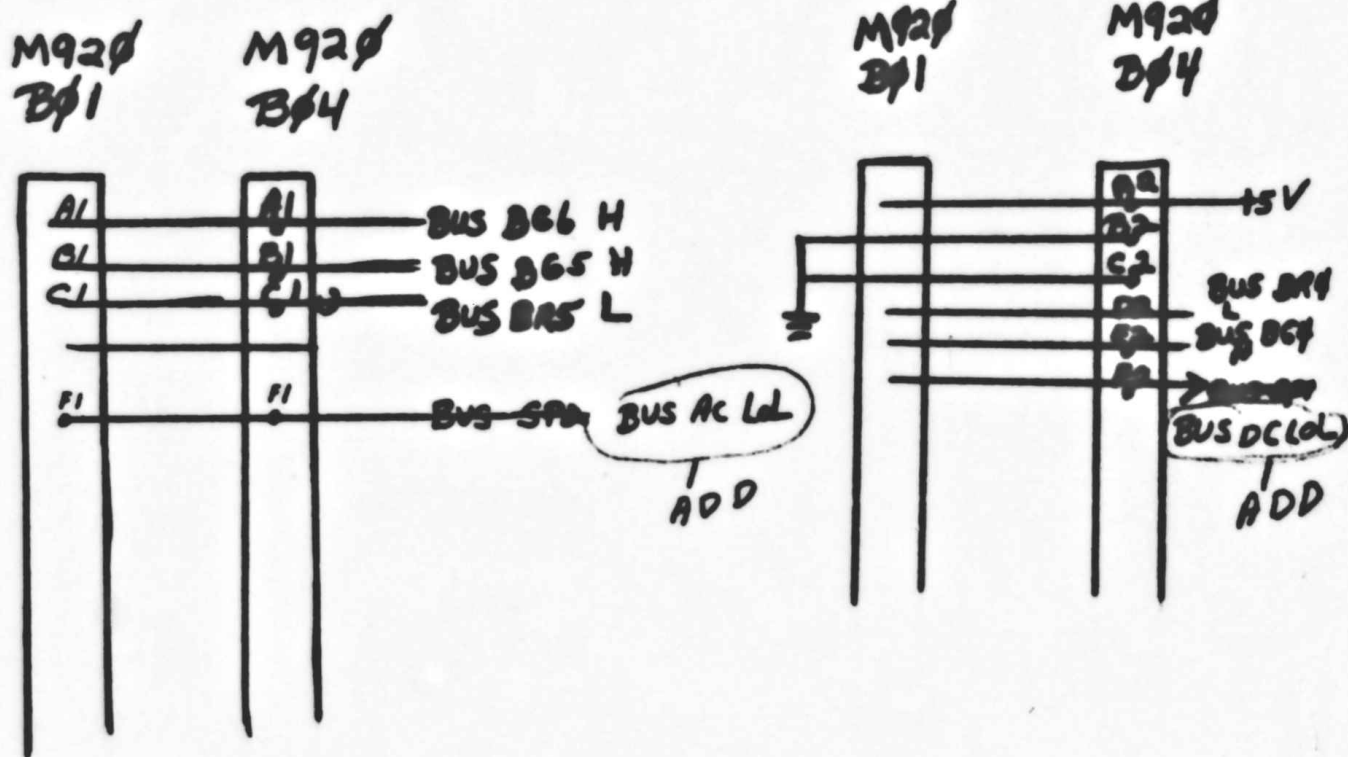

ECO # MM11E-00015

D-2C-MM11-E-09

NEW
REV.
A

DWG NO	REV LET	NO OF SHEETS	TITLE
D-IC-MM11-E-09	A	1	I/O CONNECTORS
K-WL-M11-E-07	BC	1	WIRE LIST

ECO # MM11E-00015

A-ML-MM11E

NEW
REV.
P

DWG LOC.
D-4

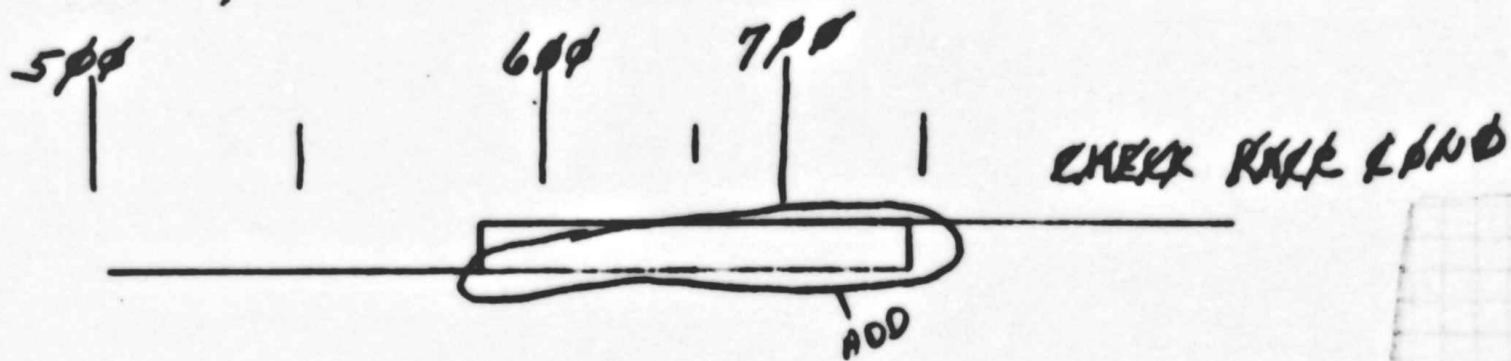

C-4+3

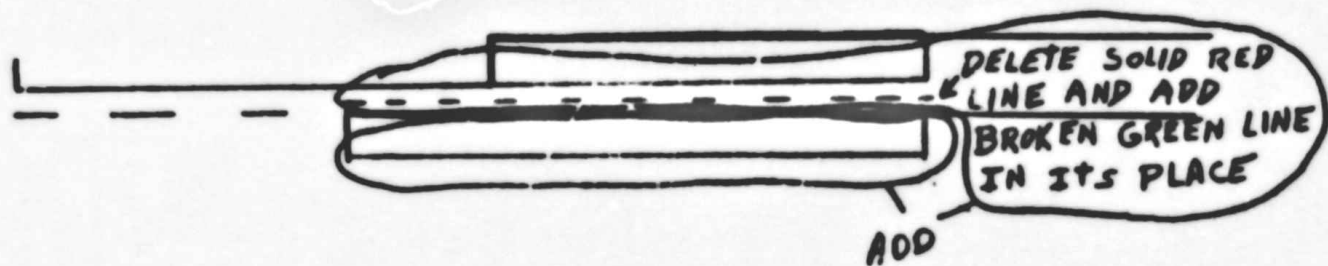

B-5

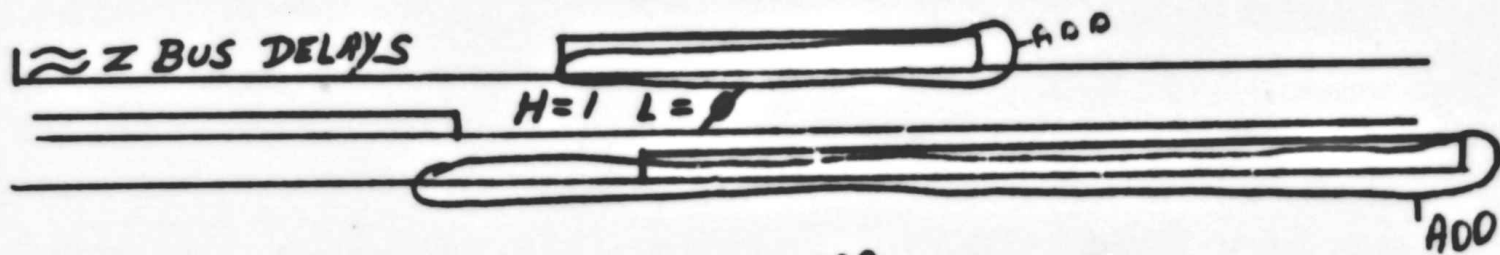

B5+6

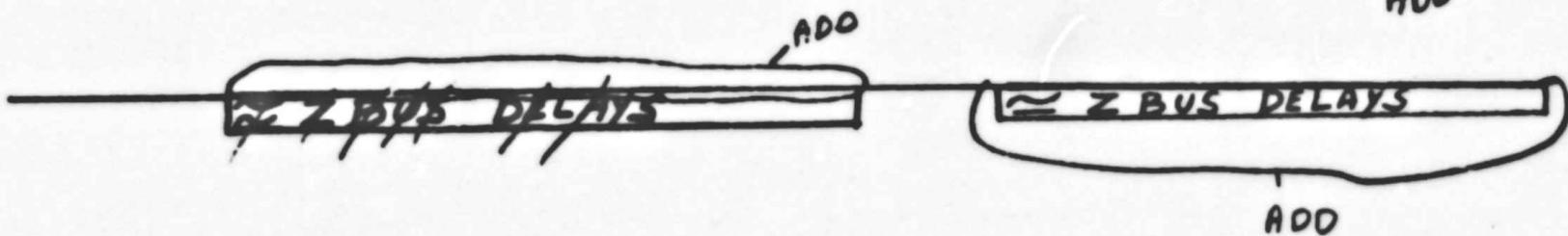

LENGTH SHOULD BE A MAXIMUM OF
 $2\frac{1}{4}$ INCHES. CHECK DRAWINGS FOR
 LENGTH AND FOR HOW LOOPS SHOULD
 BE DRESSED INTO LOGIC.

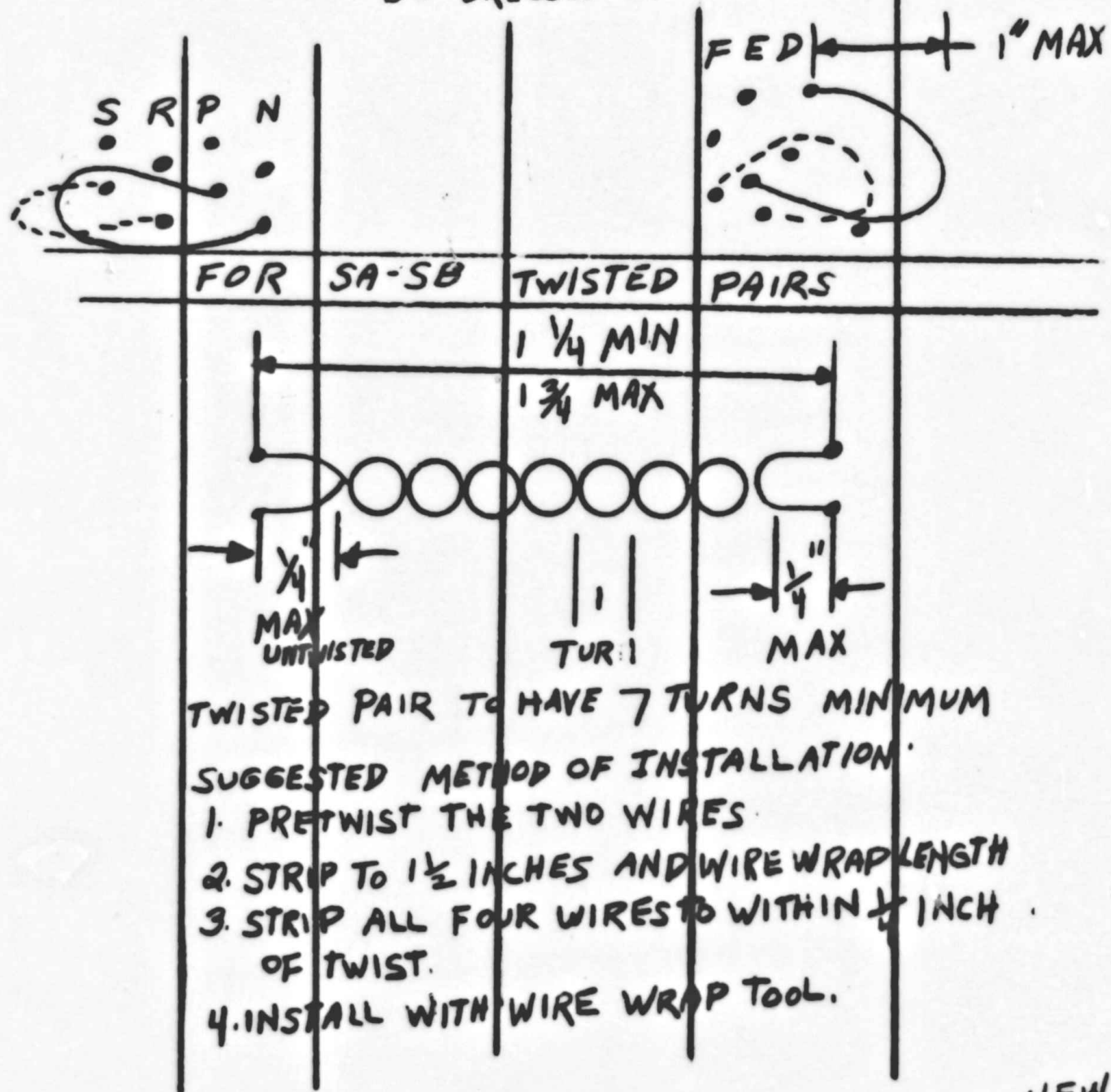

ECO# MM11E-00016 D-AD-7006468-0-0

NEW
 REV
 C

DWG NO.	REV LET
D-AD-7006468-0-0	BC
A-PL-7006468-0-0	BC
D-TD-MM11E-08	AB

ECO# MM11E-00016

A-ML-MM11E

NEW
REV.
N

digital		ENGINEERING CHANGE ORDER		ECO NO. MM11E-00017 Sheet 1 of 4
ORIGINATOR RICHARD MANION DATE 12/15/70	EXT. 2005	RECEIVED CHG. DATE 12/22/70	ISSUED ECO DATE 1-22-71	FINAL RELEASE DATE
				DISCRETE PROJECT NUMBER 11 07602
EQUIPMENT AFFECTED				
TYPE CHANGE		UNIT TO BE CHANGED	CHECKLIST	
ELECTRICAL <input checked="" type="checkbox"/>	MECHANICAL <input type="checkbox"/>	MM11-E	SHOP MODEL	YES NO <input type="checkbox"/> <input checked="" type="checkbox"/>
MODULE <input type="checkbox"/>	SUBASSEMBLY <input type="checkbox"/>	PRODUCT LINES	SYSTEMS PROGRAMS	<input type="checkbox"/> <input checked="" type="checkbox"/>
MFG/FIELD PROCEDURE <input type="checkbox"/>		PDP11	DIAGNOSTICS	<input type="checkbox"/> <input checked="" type="checkbox"/>
TEST INFORMATION			TECHNICAL PUB.	<input checked="" type="checkbox"/> <input type="checkbox"/>
SERIAL #			TEST PROGRAMS	<input type="checkbox"/> <input checked="" type="checkbox"/>
BY			TESTER	<input type="checkbox"/> <input checked="" type="checkbox"/>
			MFG/FIELD PROCEDURE	<input type="checkbox"/> <input checked="" type="checkbox"/>
			PACKAGING INSTRUCTIONS	<input type="checkbox"/> <input checked="" type="checkbox"/>
			TOOLING	<input type="checkbox"/> <input checked="" type="checkbox"/>
BREAK IN POINT			SIGNIFICANCE	
SYSTEM	MODULE/OPTION	FIELD RETROFIT	REWORK CODE	
	MM11-E	DISTRIBUTED FOR FIELD SERVICE INFORMATI.CJ ONLY	05	REQ. TO MEET SPECIFICATION <input type="checkbox"/>
				PROD. IMPROVEMENT <input checked="" type="checkbox"/>
				CUSTOMER/FIELD REQ. <input type="checkbox"/>
				FACILITATE MFG. <input type="checkbox"/>
				DRAWING CORRECTION <input checked="" type="checkbox"/>
				VENDOR <input type="checkbox"/>
PROBLEM				
1. WANTED TO IMPROVE MEMORY PERFORMANCE. STROBE 210 NS WAS TO EARLY FOR OPTIMUM PERFORMANCE . SOME TIMES CURRENT WAS TOO HIGH FOR OPTIMUM PERFORMANCE WHEN ADJUSTING THE REFERENCE VOLTAGE.				
2. WIRE LIST WAS NOT CHANGED ACCORDING TO ECO # MM11E-00015.				
3 BLOCK SCHEMATIC DOES NOT REFLECT CHANGES OF M729 CIRCUIT SCHEMATIC				
4. TIMING AND FLOW DIAGRAM NEEDS TO BE UPDATED.				
5. WRITING IN MARGIN				
CORRECTION				
1. CHANGED TEST PROCEDURE TO IMPROVE MEMORY PERFORMANCE.				
2. CORRECT WIRE LIST ACCORDING TO SUBMITTED ADD/DELETE SHEET.				
3. UPDATE BLOCK SCHEMATIC PER ATTACHED MARKED UP PRINT.				
4. UPDATE TIMING AND FLOW DIAGRAM AS INDICATED .				
5. REMOVE WRITING FROM MARGIN.				
APPROVAL				
DESIGN ENGINEER	P. DURANT	ENG. MGR.		
PRODUCTION ENGINEER	D. CALL	FIELD SERVICE (ADVISORY)	J. RIZZYNSKI	
CHIEF ENGINEER				

DRA 111A

213E

SEE REVERSE SIDE FOR INSTRUCTIONS

BY

digital

**ENGINEERING CHANGE ORDER
DOCUMENT & MATERIAL
CHANGE**

ECO NO.
MM11E-00017
Sheet 2 of 4

ITEM	DOCUMENT/OR PART NUMBER	OLD REV	NEW REV	(PART NAME) DESCRIPTION OF CHANGE	DISP CODE
1	A-ML-MM11-E	P	R	(MASTER LIST) UPDATE REVISION LEVEL ON THE FOLLOWING DRAWINGS: D-BS-MM11-E-05 FROM A TO B K-WL-MM11-E-07 FROM C TO D D-TD-MM11-E-08 FROM B TO C A-SP-MM11-E-11 FROM O TO A	06
2	D-BS-MM11-E-05	A	B	(BLOCK SCHEMATIC) SEE MARKED PRINT THIS ECO.	06
3	K-WL-MM11-E-07	C	D	(WIRE LIST) SEE ADD/DELETE SHEET THIS ECO.	06
4	D-TD-MM11-E-08	B	C	(TIMING DIAGRAM) DELETE CHECK RACE COND. IN MARGIN. INCREASE TIME AND FLOW IN DISZ BEFORE 650NS. INCREASE TIME AND FLOW IN CINZ BEFORE 350 NS.	06
5	A-SP-MM11-E-11	-	A	(ENGINEERING SPECIFICATION) DELETE FROM PARA. 11.0 210 NS . ADD 220NS. ADD TO PARA. 13.4- IF THE MARGIN IS GREATER THAN 1.0V SET VXY AT 0.5 BELOW THE FAILING HIGH END POINT. (EXAMPLE IF MARGINS ARE 0.4 TO 1.8V, SET AT 1.3V- 1.8-0.5)	06

DISPOSITION CODES

Use up Present Stock	01	Retrofit to Break-in	05
Use Present Stock until New Stock Available	02	Documentation Change Only	06
Rework all Material	03	New Item Purchase	07
Rework until New Stock Available	04	New Item in Stock	08
		New Item on Order	09
		Retain	00

DRA 112A

SEE REVERSE SIDE FOR INSTRUCTIONS

104

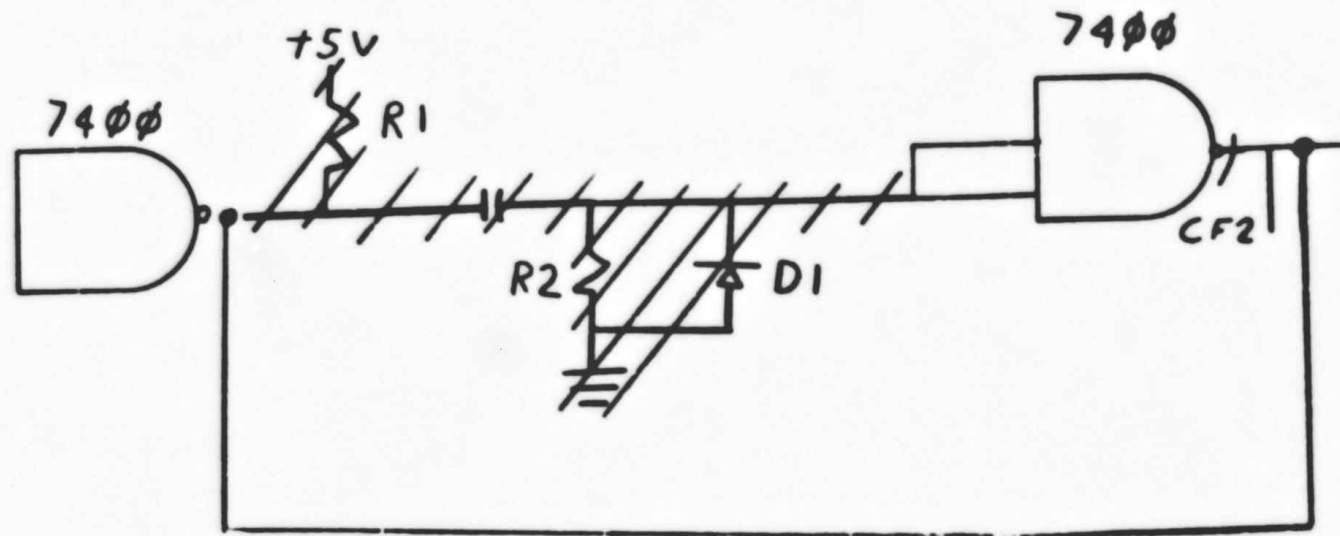

ECO# MM11E-00017

D-BS-MM11-E-05

NEW
REVB



ENGINEERING CHANGE ORDER

ECO NO.
MM11E-00020
Sheet 1 of 3

W.O. 362E CS DM

ORIGINATOR RICHARD MANION	RECEIVED CHG. DATE 3/24/71	ISSUED ECO DATE 3-26-71	FINAL RELEASE DATE 4-13-71	DISCRETE PROJECT NUMBER 11 07602
DATE 3/9/71	EXT. 2005			

EQUIPMENT AFFECTED

TYPE CHANGE	UNIT TO BE CHANGED	CHECKLIST	YES	NO
ELECTRICAL <input checked="" type="checkbox"/>	MM11E	SHOP MODEL	<input type="checkbox"/>	<input checked="" type="checkbox"/>
MECHANICAL <input type="checkbox"/>	PRODUCT LINES	SYSTEMS PROGRAMS	<input type="checkbox"/>	<input checked="" type="checkbox"/>
MODULE <input type="checkbox"/>		DIAGNOSTICS	<input type="checkbox"/>	<input checked="" type="checkbox"/>
SUBASSEMBLY <input type="checkbox"/>	PDP11	TECHNICAL PUB.	<input type="checkbox"/>	<input type="checkbox"/>
MFG/FIELD PROCEDURE <input type="checkbox"/>		TEST PROGRAMS	<input type="checkbox"/>	<input checked="" type="checkbox"/>
TEST INFORMATION		TESTER	<input type="checkbox"/>	<input checked="" type="checkbox"/>
SERIAL #		MFG/FIELD PROCEDURE	<input checked="" type="checkbox"/>	<input type="checkbox"/>
BY		PACKAGING INSTRUCTIONS	<input type="checkbox"/>	<input checked="" type="checkbox"/>
		TOOLING	<input type="checkbox"/>	<input checked="" type="checkbox"/>

BREAK IN POINT				SIGNIFICANCE	
SYSTEM	MODULE/OPTION	FIELD	REWORK	CODE	
FIELD SERVICE CODE F	MM11E	DISTRIBUTED FOR FIELD SERVICE INFORMATION ONLY		06	REQ. TO MEET SPECIFICATION <input type="checkbox"/>
					PROD. IMPROVEMENT <input checked="" type="checkbox"/>
					CUSTOMER/FIELD REQ. <input type="checkbox"/>
					FACILITATE MFG. <input type="checkbox"/>
					DRAWING CORRECTION <input checked="" type="checkbox"/>
					VENDOR <input type="checkbox"/>

PROBLEM

- 1) WANTED TO IMPROVE MEMORY PERFORMANCE. STROBE AT 220 NS AS SUGGESTED IN ECO MM11E-00017 WAS TOO LATE FOR OPTIMUM PERFORMANCE
- 2) PAR 12.0 MM11E TEST PROCEDURE INCORRECT. V THRESHOLD SET TO -5.3V IS TOO LOW.

CORRECTION

- 1) CHANGE STROBE SETTING AS STATED IN PARAGRAPH 11.0 FROM 220 NS TO 210 NS
- 2) CHANGE TEST PROCEDURE . SET V THRESHOLD AT -5.2V

NOTE: REF. ECO MM11E-00017 PROBLEM 1. IF THE CORRECTION FOR PROBLEM (1) IN ECO MM11E-00017 WAS NOT PERFORMED IT WILL NOT BE NECESSARY TO IMPLEMENT CORRECTION (1) OF THIS ECO.

APPROVAL

DESIGN ENGINEER P. DURANT 3/2/71 ENG. MGR. _____

PRODUCTION ENGINEER DON CALL 3/3/71 FIELD SERVICE
(ADVISORY) J. BUZYNSKI

CHIEF ENGINEER _____

DRA 111A

SEE REVERSE SIDE FOR INSTRUCTIONS

F4

digital

**ENGINEERING CHANGE ORDER
DOCUMENT & MATERIAL**

ECO NO.
MM11E-00020
Sheet 2 of 3

ITEM	DOCUMENT/OR PART NUMBER	OLD REV	NEW REV	(PART NAME) DESCRIPTION OF CHANGE	DISP CODE
1	A-ML-MM11-E	T	U	(MASTER LIST) UPDATE REVISION LEVEL OF ITEM 3 THIS ECO	06
2	A-ML-MM11-EX	-	A	(MASTER LIST) SAME CHANGE AS ITEM 1 THIS ECO	06
3	A-SP-MM11E-11	A	B	(TEST PROCEDURE) SHEET 4 OF 5; DELETE 220 NS IN PARAGRAPH 11.0 ADD 210 NS DELETE -5.3V IN PARAGRAPH 12.0 ADD -5.2V UPDATE REVISION LEVEL ON ALL SHEETS	06

DISPOSITION CODES

Use up Present Stock	01	Retrofit to Break-in	06
Use Present Stock until New Stock Available	02	Documentation Change Only	06
Rework all Material	03	New Item Purchase	07
Rework until New Stock Available	04	New Item in Stock	08
		New Item on Order	09
		Retain	00

DRA 112A

SEE REVERSE SIDE FOR INSTRUCTIONS

64

FIELD SERVICE NOTES:

ECO MM11E-00020
Page 3 of 3

C LEVEL OF URGENCY code

The ECO number will be posted to the EDP file with this LOU code replacing the lead # - "A" = Mandatory, High Priority
"B" = Mandatory "C" = Applicable if symptoms are present
"D" = Low Priority "D" = Product Improvement, Optional

Yes This ECO is NO CHARGE TO CUSTOMER - All DEC installation labor and materials are to be reported under a "W" charge code.

No This ECO is STANDARD APPLICABILITY - It is to be installed at no charge for warranty and maintenance contract customers in accordance with the technical effectivity, otherwise at customer expense.
Charges - Documentation \$ N/C, Parts \$ NONE
DEC on-site labor \$ N/C. (minimum per call billing applies)
(* parts prices not available at the time of Speco release)

F FIELD DISTRIBUTION CODE

"F" = Immediate Speco distribution to all field offices
"DF" = No general Speco distribution, only to offices where equipment is located (less than 25 units in the field)

No UNCONDITIONAL ECO - General distribution kits will include Field Installation Orders, Specos, Prints, and Parts.

Yes CONDITIONAL ECO - General distribution will include Field Installation Orders only. Prints and parts must be ordered from FSIC as required.

No Parts availability delay expected _____.

Yes The REQUIREMENT TO MEET SPECIFICATION is applicable retroactively to equipment in the field.

NOTE:



ENGINEERING
CHANGE ORDER 8527

ORIGINATOR Richard Manion *S-2*
TEL EXT 2005 DATE 3/13/72
DISC PROJ NO. 11 07602
COST CENTER NO. 392 *A.F.*

ECO NO. *MM11E-00022*
SHEET *1* OF *3*
DATE RECEIVED *3-16-72*
FIRST ISSUE *3-21-72*
FINAL ISSUE

PROBLEM
Under some conditions when other options are placed along side an MM11/E they fail to operate correctly.

UNIT TO BE CHANGED
MM11/E
Memory
DISP CODE ~~74~~

CORRECTION
Install a module protection plate.

OPTIONS AFFECTED
MM11/E

BREAK-IN/EFFECTIVITY
*Install module protection plate only when problems occur.

PRODUCT LINES AFFECTED
PDP11/20

ITEM NO.	DOCUMENT/PART NO.	OLD REV	NEW REV	DISP CODE	DESCRIPTION OF CHANGE
1.	C-DI-MM11-E-01	<i>D</i>	<i>E</i>	06	(Drawing Index Memory) Change per this ECO.
2.	7408490	-	-	07	(Module Protection Plate) Add quantity of 1 to drawing index.
3.	A-ML-MM11-E	<i>V</i>	<i>W</i>	06	Update per item 1.

- DOCUMENTATION AFFECTED
- MODEL
 - DIAGNOSTICS
 - TECH MANUAL
 - TESTER
 - TEST PROG
 - TOOLING
 - PKG INST
 - ENG SPEC
 - PURCH SPEC

- FIELD SERVICE AFFECTED
- YES NO
 - Customer Champ
 - Product Line Champ

- TYPE OF CHANGE
- ELECTRICAL
 - MECHANICAL
 - MODULE
- ORDER PR MODEL
- YES
 - NO

- DISPOSITION CODES**
- 00 - RETURN TO STOCK
 - 01 - (DELETED)
 - 02 - USE PRESENT STOCK UNTIL NEW STOCK AVAILABLE (PHASE IN)
 - 03 - REWORK IMMEDIATELY (RETROFIT)
 - 04 - (DELETED)
 - 05 - (DELETED)
 - 06 - DOCUMENT CORRECTION
 - 07 - NEW ITEM (THIS ASSEMBLY)
 - 08 - NEW ITEM (THIS COMPANY)
 - 09 - SCRAP IMMEDIATELY

APPROVAL SIGNATURES

Typewritten Hand Signature

DESIGN ENGR *Pete Durant*

ENG MGR (OPT) _____

FIELD SERVICE (OPT) _____

CHIEF ENGR (MODULES ONLY) *R. Durant*

EVEN

ODD

24

ECO MM11E-00022
MM11E REWORK SHEET

SHEET 2 OF 2

1. LOOSEN 2 SCREWS AT POINTS A, CARE SHOULD BE USED AT ALL TIME SO, THAT NO WIRES WILL BE DAMAGED.
2. SLIDE THE FINGERS OF THE MODULE PROTECTION PLATE UNDER THE GND LUGS. THE PROTECTION PLATE SHOULD BE RIGHT AGAINST THE WIRED ASSY. FRAME, POINTS B.
3. TIGHTEN SCREWS.

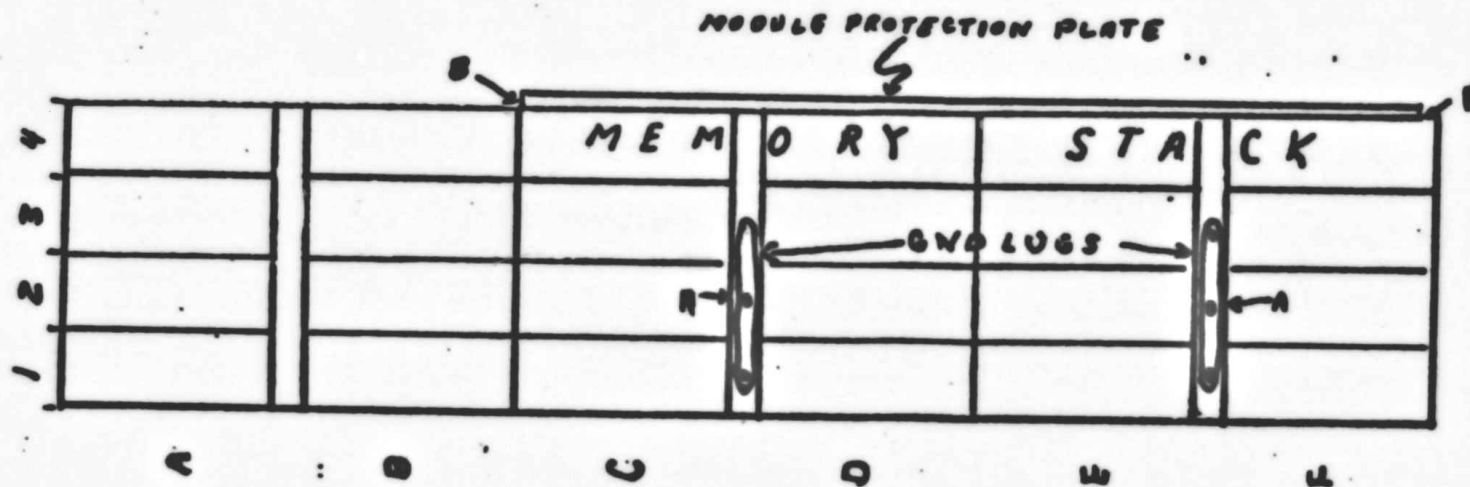

 ENGINEERING CHANGE ORDER	TITLE	ENG NO.	REV
	JRN <i>ALYCE FUERTADO</i>		
	ENG'D <i>Cutter</i>	ENG LOC.	GRAPHIC DESCRIPTION



FIELD CHANGE ORDER

7527

FCO MM11E - D 0022
PAGE 3 OF 3

DATA PROCESSING AND DEC-ECO-LOG WILL POST THIS FCO WITH THE LEVEL OF URGENCY CODE REPLACING THE LEADING ZERO.

FIELD EFFECTIVITY

MM11-E Memory Assembly

FIELD RETROFIT IS ANTICIPATED IN 5 % OF UNITS DEFINED ABOVE

NO CHARGE TO CUSTOMER - ALL DEC INSTALLATION LABOR AND MATERIAL ARE TO BE REPORTED UNDER A "W" CHARGE CODE.

STANDARD APPLICABILITY - THIS FCO IS TO BE INSTALLED AT NO CHARGE FOR WARRANTY AND MAINTENANCE CONTRACT CUSTOMERS IN ACCORDANCE WITH THE TECHNICAL EFFECTIVITY ABOVE, OTHERWISE AT CUSTOMER EXPENSE.

DOCUMENTATION 0 PARTS 0 DEC ON-SITE LABOR 0

DEC'S MINIMUM BILLING APPLIES IF THIS FCO IS INSTALLED BY DEC. THE DEC LABOR CHARGE ASSUMES FCO INSTALLATION DURING REGULAR WORKING HOURS. IF INSTALLATION OUTSIDE OF REGULAR WORKING HOURS IS ORDERED, DEC'S LATEST SCHEDULE OF HOURLY RATES WILL APPLY.

FIELD OFFICE FCO DISTRIBUTION CODE

F IMMEDIATE FCO DISTRIBUTION TO ALL DEC FIELD OFFICES
 DF IMMEDIATE FCO DISTRIBUTION TO REGIONAL, PRODUCT SUPPORT AND TO OFFICES WHERE SUBJECT EQUIPMENT IS LOCATED.

FCO KIT DISTRIBUTION

PSIC WILL INITIATE DISTRIBUTION OF FCO KITS AS DEFINED BELOW IN ACCORDANCE WITH THE EDP CONFIGURATION FILE.

~~FCO INFORMATION ORDERS SHOULD BE OBTAINED.~~ KITS, AS DEFINED BELOW, MAY BE ORDERED AS REQUIRED.

CONTENTS OF AN PSIC INITIATED KIT

FIO	FCO	PRINTS	PARTS

CONTENTS OF A FIELD ORDERED KIT

FIO	FCO	PRINTS	PARTS
	X	X	X

PSIC INITIATED FCO KITS WILL BE DISTRIBUTED FOR ALL UNITS LISTED ON THE EDP CONFIGURATION FILE WITH THE FOLLOWING SERVICE STATUS CODES:

D H K W

PRINT CHANGES ARE MINIMAL AND ARE TO BE MADE MANUALLY IN RED AND GREEN. FCO REVISED PRINTS WILL BE SUPPLIED ONLY UPON SPECIAL REQUEST.

INSTALLATION AND TEST PROCEDURES

- Carefully install module protection plate per FCO instructions. This requires insertion of the plate under existing wire runs which are easily broken.
- Run maindecs or other programs whose failure indicated the need for this FCO to be implemented. They should now function correctly.

LEVEL OF URGENCY CODE

- A MANDATORY - HIGH PRIORITY
- B MANDATORY
- C HIGH PRIORITY IF SPECIFIC HARDWARE, SOFTWARE, OR SYMPTOMS ARE PRESENT
- D APPLICABLE IF SPECIFIC HARDWARE, SOFTWARE, OR SYMPTOMS ARE PRESENT
- E PRODUCT IMPROVEMENT - OPTIONAL - LOW PRIORITY

DISCRETE PROJECT NUMBER (FOR FIELD SERVICE REPORTING)

AVAILABILITY DELAY	NO PARTS
PARTS <u>NONE</u>	

ESTIMATED DOWN TIME FOR INSTALLATION AND TESTING 1.0 HOURS

SPECIAL TEST EQUIPMENT, TOOLS, OR SUPPLIES

LAST PREVIOUS FCO'S C020, C016, 015

RELATED OR PREREQUISITE FCO'S

- MAINDEC CHANGE
- MAINTENANCE MANUAL CHANGE
- OPERATIONAL PROGRAMS AFFECTED

VERIFICATION MAINDECS

PARTS REQUIRED

Q1 74-08490 Module Protection Plate

NOTES

FIELD SERVICE APPROVAL
Charles Dewey

ask
3/20 3/24 (0) 3/24 75

THIS DOCUMENT WAS NOT PRODUCED FOR MICROFICHE; THEREFORE, ONLY PARTS OF IT ARE READABLE.

24

digital

ENGINEERING CHANGE ORDER

ORIGINATOR R. Manion 1-3
TEL EXT 2005 DATE 5-6-72
DESC PROJ NO. D-96-6122
COST CENTER NO. 392

A.F.

ECO NO. MM11-0024
SHEET OF
DATE RECEIVED 5-9-72
FIRST ISSUE 5-10-72
FINAL ISSUE 6-24-72

PROBLEM 1. STROBE Signals and TINH have too much noise on them.
2. Read H signal has too many loads on it.

UNIT TO BE CHANGED
MM11-E

DISP CODE 03

OPTIONS AFFECTED

MM11-E

CORRECTION

1. Install twisted pairs for these signals.
2. Develop another Read H signal to share the load.

BREAK-IN/EFFECTIVITY All MM11-E's shipped after May 12 will have this ECO.
Rework M729 Module when necessary, all MM11-E's with this ECO, MUST have M729's with ECO # 2.

PRODUCT LINES AFFECTED

PDP-11/45
PDP-11/20
PDP-11/45

ITEM NO.	DOCUMENT/PART NO.	OLD REV	NEW REV	DISP CODE	DESCRIPTION OF CHANGE	DOCUMENTATION AFFECTED	FIELD SERVICE AFFECTED	TYPE OF CHANGE
1	K-WL-MM11-E-07	D	E	06	Wire List Update	<input type="checkbox"/> MODEL	<input checked="" type="checkbox"/> YES <input type="checkbox"/> NO	<input checked="" type="checkbox"/> ELECTRICAL
2	D-AD-7006468-0-0	D	E	06	Wire Ass'y MM11-E See final release print.	<input type="checkbox"/> DIAGNOSTICS	<input type="checkbox"/> Customer Charge	<input type="checkbox"/> MECHANICAL
3	D-BS-MM11-E-03	A	B	06	Core Memory stack (2 sheets) See final release print.	<input type="checkbox"/> TECH MANUAL	<input checked="" type="checkbox"/> Product Line Change	<input type="checkbox"/> MODULE
4	A-ML-MM11-E	Z	AA	06	UPDATE PRINT PER THIS E.C.O.	<input type="checkbox"/> TESTER		<input type="checkbox"/> ORDER PR MODEL
5	C-DI-MM11-E-01	E	F	06	UPDATE PRINT PER THIS E.C.O.	<input type="checkbox"/> TEST PROG		<input type="checkbox"/> YES
6	A-PL-7006468-0-0	D	E	06	UPDATE REV PER THIS E.C.O.	<input type="checkbox"/> TOOLING		<input type="checkbox"/> NO
						<input type="checkbox"/> PKG INST		
						<input type="checkbox"/> ENG SPEC		
						<input type="checkbox"/> PURCH SPEC		

DISPOSITION CODES

- 00 - RETURN TO STOCK
- 01 - (DELETED)
- 02 - USE PRESENT STOCK UNTIL NEW STOCK AVAILABLE (PHASE IN)
- 03 - REWORK IMMEDIATELY (RETROFIT)
- 04 - (DELETED)
- 05 - (DELETED)
- 06 - DOCUMENT CORRECTION
- 07 - NEW ITEM (THIS ASSEMBLY)
- 08 - NEW ITEM (THIS COMPANY)
- 09 - SCRAP IMMEDIATELY

APPROVAL SIGNATURES

Typewritten / Hand Signature

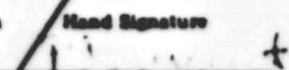
DESIGN ENGR Pete Durant 

ENG MOR (OPT) _____

FIELD SERVICE (OPT) _____

CHIEF ENGR (MODULES ONLY) _____



ENGINEERING CHANGE ORDER
ADD/DELETE SHEET

ECO NO.
MM11E-00024
Sheet ___ of ___

WIRE LIST NO. K-WL-MM11-E-07

TITLE

MM11E

MAKE ALL DELETIONS FIRST WHEN INSTALLING

SIGNAL NAME	FROM PIN	TO PIN	COMPONENTS	ADD	DEL
READ H	C02V2	D01A1	REMARKS		X
READ 01 H	C01F2	C02C1		X	
STROBE 0 H	C01F1	D02S1			X
STROBE 01 H	C01A1	E02S1			X
TINH 0 H	D02E1	E01S1			X
TINH 1 H	E01H2	F01F1			X
STROBE 0 H	C01F1	D02S1	WHT	X	
GND	C01C2	D02T1	BLK	TWP	X
STROBE 01 H	C01A1	E02S1	WHT	X	
GND	C01C2	E03T1	BLK	TWP	X
T 0 INH	E01S1	D02E1	WHT	X	
GND	E01C2	D01C2	BLK	TWP	X
T 1 INH	E01H2	F01E1	WHT	X	
GND	E01C2	F01C2	BLK	TWP	X

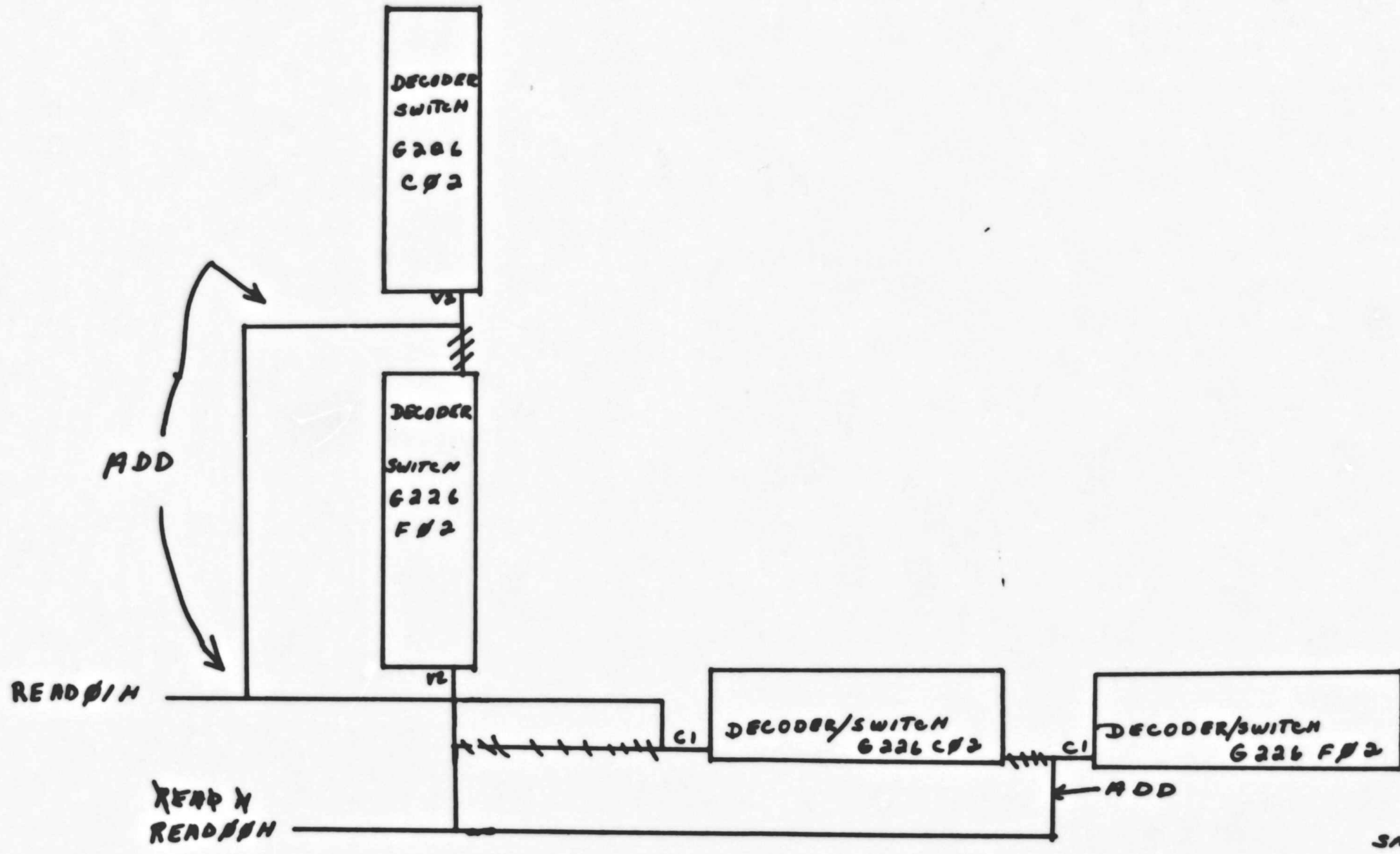

SHEET 192

digital	CORP. MEMORY STACK (X DRIVE)		DWG NO. D-05-MM11E-03	REV B
	ENGINEERING CHANGE ORDER	URN <i>Ally...</i>		
	CHK'D <i>Cathy</i>	ENG. LOC.		

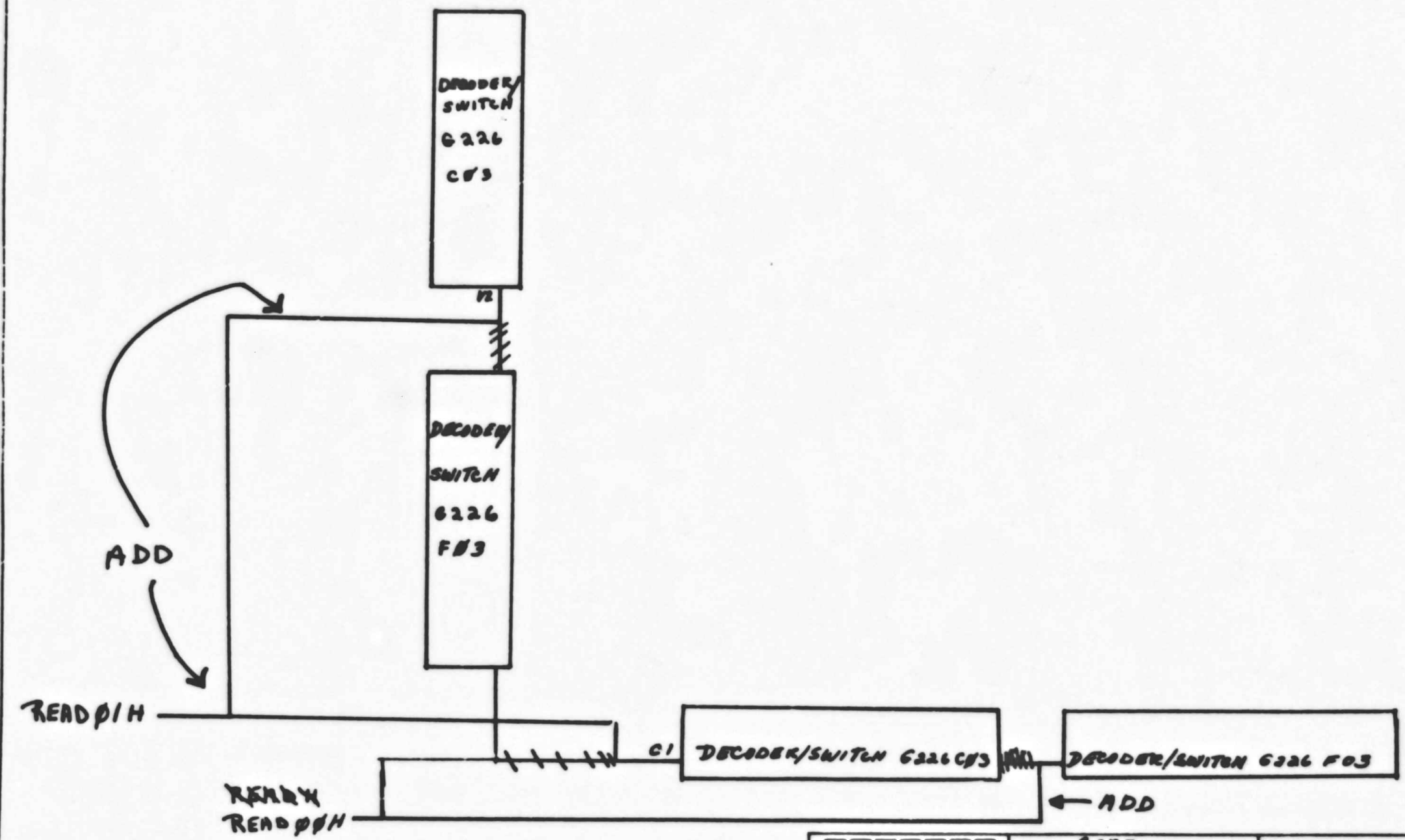

SHEET 2 of 2

digital ENGINEERING CHANGE ORDER	TITLE CORE MEMORY STACK (Y DRIVER)	Dwg NO. D-BS-MM11E-03	REV B
	ORIN <i>W. J. ...</i>		

ECO NO. MM116-0002Y

WIRE TABLE

SIGNAL NAME	FROM PIN	TO PIN	COLOR	REMARKS	SIGNAL NAME	FROM PIN	TO PIN	COLOR	REMARKS
STROBE PH GND	CA1A1 CA1C2	ED2E1 ED3T1	WHT BLK	TWP	TO INH GND	EO1S1 EO1C2	DO2E1 DO1C2	WHT BLK	TWP
					TI INH GND	EO1N2 EO1C2	FO1E1 FO1C2	WHT BLK	TWP
					STROBE PH GND	CO1P1 CO1C2	DO3S1 DO2T1	WHT BLK	TWP

ADD

digital	WIRED ASS'Y		Dwg. NO. D-AD-700142-1-0 REV E
	MM11-B		
ENGINEERING CHANGE ORDER	DRN <i>Alan Smith</i>	CHK'D <i>Cathy</i>	GRAPHIC DESCRIPTION

digital

FIELD CHANGE ORDER

4.5

FCO MM11E - B 0024
PAGE OF

DATA PROCESSING AND DEC-ECO-LOG WILL POST THIS FCO WITH THE LEVEL OF URGENCY CODE REPLACING THE LEADING ZERO.

FIELD EFFECTIVITY

Retrofit all MM11-E's

FIELD RETROFIT IS ANTICIPATED IN 100 OF UNITS DEFINED ABOVE

NO CHARGE TO CUSTOMER - ALL DEC INSTALLATION LABOR AND MATERIAL ARE TO BE REPORTED UNDER A "W" CHARGE CODE.

STANDARD APPLICABILITY - THIS FCO IS TO BE INSTALLED AT NO CHARGE FOR WARRANTY AND MAINTENANCE CONTRACT CUSTOMERS IN ACCORDANCE WITH THE TECHNICAL EFFECTIVITY ABOVE, OTHERWISE AT CUSTOMER EXPENSE.

DOCUMENTATION PARTS DEC ON-SITE LABOR

DEC'S MINIMUM BILLING APPLIES IF THIS FCO IS INSTALLED BY DEC THE DEC LABOR CHARGE ASSUMES FCO INSTALLATION DURING REGULAR WORKING HOURS. IF INSTALLATION OUTSIDE OF REGULAR WORKING HOURS IS ORDERED, DEC'S LATEST SCHEDULE OF HOURLY RATES WILL APPLY.

FIELD OFFICE FCO DISTRIBUTION CODE

F IMMEDIATE FCO DISTRIBUTION TO ALL DEC FIELD OFFICES
 DF IMMEDIATE FCO DISTRIBUTION TO REGIONAL PRODUCT SUPPORT AND TO OFFICES WHERE SUBJECT EQUIPMENT IS LOCATED

FCO KIT DISTRIBUTION

FSIC WILL INITIATE DISTRIBUTION OF FCO KITS AS DEFINED BELOW IN ACCORDANCE WITH THE EDP CONFIGURATION FILE

~~Some Information Changes...~~ KITS, AS DEFINED BELOW, MAY BE ORDERED AS REQUIRED

CONTENTS OF AN FSIC INITIATED KIT

FIO	FCO	PRINTS	PARTS

FSIC INITIATED FCO KITS WILL BE DISTRIBUTED FOR ALL UNITS LISTED ON THE EDP CONFIGURATION FILE WITH THE FOLLOWING SERVICE STATUS CODES

CONTENTS OF A FIELD ORDERED KIT

FIO	FCO	PRINTS	PARTS
	X	X	

D H K W

PRINT CHANGES ARE MINIMAL AND ARE TO BE MADE MANUALLY IN RED AND GREEN FCO REVISED PRINTS WILL BE SUPPLIED ONLY UPON SPECIAL REQUEST

INSTALLATION AND TEST PROCEDURES

LEVEL OF URGENCY CODE

- A MANDATORY - HIGH PRIORITY
- B MANDATORY
- C HIGH PRIORITY IF SPECIFIC HARDWARE, SOFTWARE, OR SYMPTOMS ARE PRESENT
- D APPLICABLE IF SPECIFIC HARDWARE, SOFTWARE, OR SYMPTOMS ARE PRESENT
- E PRODUCT IMPROVEMENT - OPTIONAL - LOW PRIORITY

DISCRETE PRODUCT NUMBER (FOR FIELD SERVICE REPORTING)

AVAILABILITY DELAY	NO PARTS
PARTS	X

ESTIMATED DOWN TIME FOR INSTALLATION AND TESTING 1.0 HOURS

SPECIAL TEST EQUIPMENT, TOOLS, OR SUPPLIES

LAST PREVIOUS FCO'S D022, C020, C017

RELATED OR PREREQUISITE FCO'S
M729-00003

- MAINTENANCE CHANGE
- MAINTENANCE MANUAL CHANGE
- OPERATIONAL PROGRAMS AFFECTED

VERIFICATION MAINDCS

PARTS REQUIRED

WTMS

Necessary to improve reliability on existing units.

FIELD SERVICE APPROVAL
Art Hines

5/11 5/17 (1534) 5/17 800

THIS DOCUMENT WAS NOT PRODUCED FOR MICROFICHE; THEREFORE, ONLY PARTS OF IT ARE READABLE.

DS

FCR

ES

**MM11-E
PDP-11 MEMORY
FCO Cross Reference**

**A Chronological Listing of Field Retrofit FCO's Which Must Be
Considered in the Field Installation and Maintenance of This Option/Module/Power Supply**

• Indicates FCO Conjunction Must Be Considered With Prior FCO

- | | |
|--|--|
| <p>■ G102-B0002 MAR 70
G102-B0003
QUICK SYNOPSIS
8881 IC's replaced by higher speed 74H011 IC's.
QUICK CHECK
74H011 IC's in place of 8881 IC's.
NEW REVISION
Exchange with CS B or later.</p> | <p>■ G103-C0005 JUN 70
QUICK SYNOPSIS
Provides increase to -6.8VDC for sense amplifiers.
QUICK CHECK
Heat sink ADD'ed to Q4; C1 and C2 changed from 1000mmfd to 820mmfd.
NEW REVISION
Rework etch D, E to CS D.</p> |
| <p>■ G103-C0002 MAR 70
QUICK SYNOPSIS
Increases system speed.
QUICK CHECK
7410 IC replaced by 74H10 IC.
NEW REVISION
Rework etch B, C to CS B.</p> | <p>■ G225-C0003 JUL 70
QUICK SYNOPSIS
Speeds stabilization of X and Y current generator reference voltage.
QUICK CHECK
R22 changed from 4.7K ohms to 2.2K ohms.
NEW REVISION
Rework etch B to CS B.</p> |
| <p>■ G103-C0004 APR 70
QUICK SYNOPSIS
Provides new higher value trimpot.
QUICK CHECK
R17 changed from 100 ohm to 500 ohm trimpot.
NEW REVISION
Rework etch B, C to CS C.</p> | <p>■ MM11E-C0016 AUG 70
QUICK SYNOPSIS
Provides wire table and wiring instructions to ensure correct memory margins and G102 interchangeability.</p> |
| <p>■ G102-B0004 JUN 70
QUICK SYNOPSIS
Decreases turn-off time of the 2007 transistors.
QUICK CHECK
C2, C7, C12, C17 changed from 1000mmfd to 820mmfd.
NEW REVISION
Rework etch D to CS D.</p> | <p>■ MM11E-A0016 SEP 70
QUICK SYNOPSIS
Connects AC LO L and DC LO L signal from the Power Bus to the Unibus to ensure proper Power Fail.
QUICK CHECK
BUS AC LO L tied to pin F1.
NEW REVISION
Rework to Wire List B.</p> |

**MM11-E
PDP-11 MEMORY
FCO Cross Reference**

A Chronological Listing of Field Retrofit FCO's Which Must Be Considered in the Field Installation and Maintenance of This Option/Module/Power Supply

• Indicates FCO Conjunction Must Be Considered With Prior FCO

- **M930-C0001 AUG 70**
QUICK SYNOPSIS
Power Fail requires BUS SP1 and BUS SP2 for AC LO and DC LO. (In-plant, new etch B at CS A.)
QUICK CHECK
R57 and R69 are 390 ohms.
NEW REVISION
Rework etch B to CS A.
- **5408475-C0008 OCT 70**
QUICK SYNOPSIS
AC LO and DC LO returns high after assertion in multiple box systems.
QUICK CHECK
D003 clamping diodes from AC LO (anode) and from DC LO to +5V line.
NEW REVISION
Rework etch A, B, C to CS D.
- **MM11E-C0017 JAN 71**
MM11E-C0020
QUICK SYNOPSIS
Improves memory performance.
QUICK CHECK
Wire ADD B04F2 to A03S2.
- **M729-C0002 JAN 71**
QUICK SYNOPSIS
Reduces memory cycle time on systems with 8K interleaved memory. (In-plant, new etch C.)
QUICK CHECK
Wire ADD E9 pin 2 to feed-thru near E5 pin 1.
NEW REVISION
Rework etch B to CS B.
- **M1091-C0001 MAR 71**
QUICK SYNOPSIS
Provides 1 unit load on BUS in systems with 16K or more memory.
QUICK CHECK
M1091 replaced M109 module.
NEW REVISION
Rework etch B to CS A.
- **G102-B0008 APR 71**
QUICK SYNOPSIS
Eliminates MM11-F's noise susceptibility.
QUICK CHECK
C3, C8, C13, C18 changed from 33mmfd to 120mmfd.
NEW REVISION
Rework etch D to CS D.
- **G225-C0007 MAY 71**
QUICK SYNOPSIS
Prevent heat sinks from shorting to etch.
QUICK CHECK
Insulating washers under heat sinks.
- **M7290-C0002 OCT 71**
QUICK SYNOPSIS
Prevents Unibus hang with SSYN asserted from memory. (In-plant, new etch E.)
QUICK CHECK
Wire ADD E8 pin 5 to E7 pin 9.
NEW REVISION
Rework etch C to CS D.
- **MM11E-D0022 MAR 77**
QUICK SYNOPSIS
Module protection plate prevents MM11-E noise interaction with adjacent modules.
QUICK CHECK
Presence of protection plate.
- **MM11E-B0024 MAY 72**
QUICK SYNOPSIS
Reduces noise on TINH and strobe signals.
QUICK CHECK
Wire ADD C01F1 to D02S1/C01C2 to D02T1.
NEW REVISION
Rework to Wire List E.

**MM11-E
PDP-11 MEMORY
FCO Cross Reference**

**A Chronological Listing of Field Retrofit FCO's Which Must Be
Considered in the Field Installation and Maintenance of This Option/Module/Power Supply**

• Indicates FCO Conjunction Must Be Considered With Prior FCO

■ **M729-C0003 MAY 72
M729-D0004**

QUICK SYNOPSIS

Unibus hangs with Ssyn asserted from memory.

QUICK CHECK

Wire ADD E5 pin 8 to E3 pin 1.

NEW REVISION

Rework etch B, C to CS C.

■ **M7290-C0003 MAY 72**

QUICK SYNOPSIS

Reduced inductance of the TINH H etch corrects noise condition. (In-plant, new etch F.)

QUICK CHECK

Wire ADD E11 pin 8 to feed-thru going to AR1.

NEW REVISION

Rework etch C, D to CS E.

**ECO
QUICK CHECK**

MM11-E/F FIELD CODED ECO's

G102	B2, B3, C4, B6
G103	C2, C4, C5, C7
G225	C3, C7
G226	C4
M729	B2, C3 & A & B
M1091	C1
M7290	C2, C3
MM11-E	C15, C16, C17, C20, D22, B24
MM11-F	D1, C3

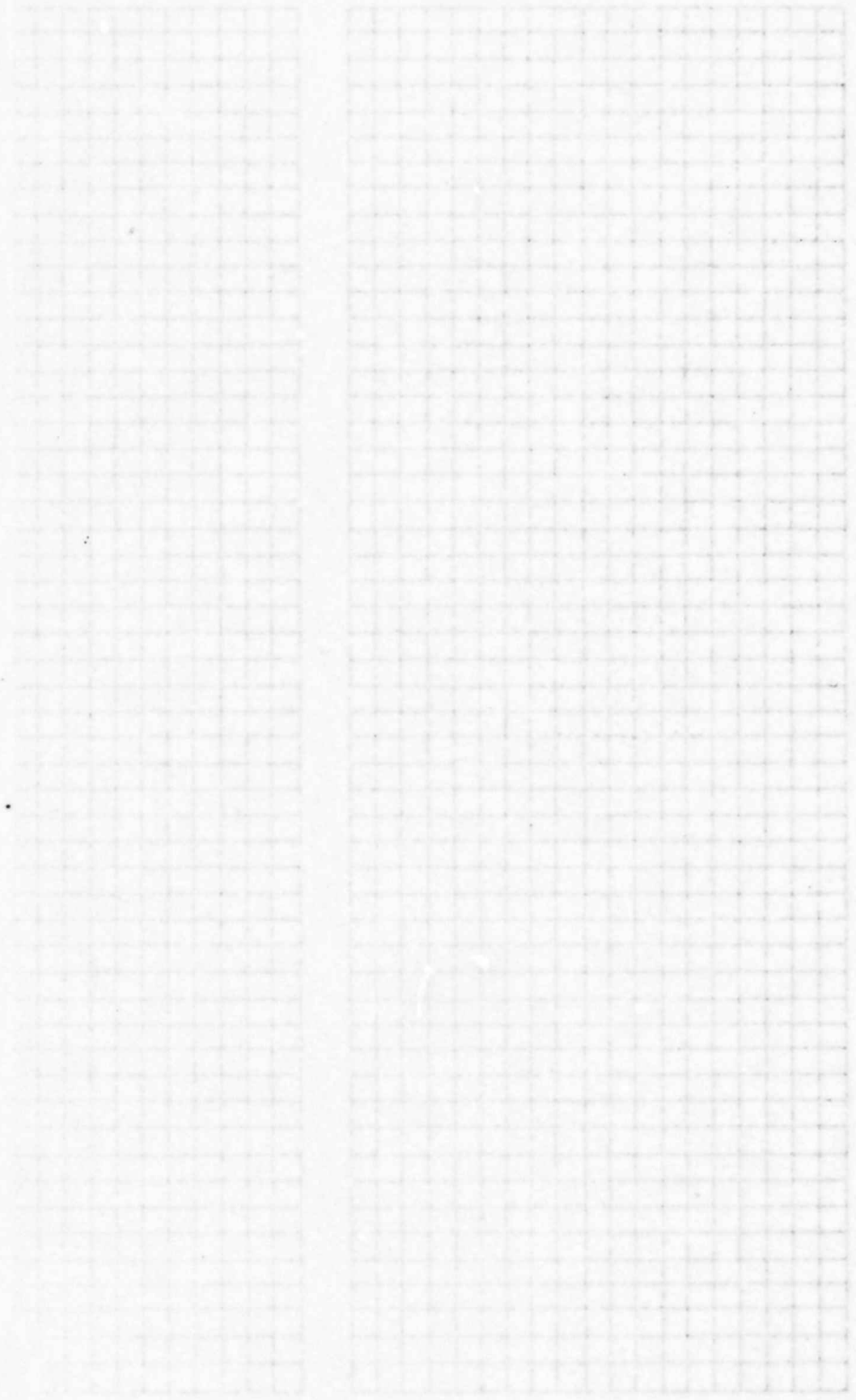

MM11-E/F ECO PARTS

<u>NAME</u>	<u>ECO#</u>	<u>QTY</u>	<u>PART NUMBER</u>	<u>COMMENTS & DESCRIPTION</u>
G102	#2	1	19-09849	I.C.
	#3	8	13-03064	Resistor
	#4	4	10-00027	Capacitor
		4	13-09995-0	Resistor
		1	16-09996-0	Indicator
	#6	4	10-00018	Capacitor
G103	#2	3	19-09057	I.C.
	#4	1	13-05631	Resistor
	#5	2	13-02602	Resistor
		2	13-09994-0	Resistor
		1	13-00295	Resistor
		2	10-00027	Capacitor
		1	11-09991	Diode
		1	11-09990	Diode
		1	16-09996-0	Conductor
	1	12-10001-0	Heat sink	
	#7	1	10-10274	Capacitor
G225	#3	1	13-00417	Resistor
	#7	4	90-08493	Washers
		A/R	90-08268	Thermal compound
G226	#4	1	10-10274	Capacitor
M792	#3	1	19-05547	I.C.
M1091	#1	1	M1091 etch "B"	if applicable module
MM11-F	#1	1	74-08490	Memory shield
MM11-E	#2	1	74-08490	Memory shield

MM11-E/F PARTS BREAKDOWN

7006405
7006468
70007263

- Logic Frame
- MM11-E Wired assembly
- MM11-F Wired assembly

G102

- Sense Inhibit Card

G103

- Memory Levels & Gates

G225

- X-Y Current Generator

G226

- X-Y Current Generator

H207

- 4K 16 Bit Core Memory Stack

M109

- Device Select

M729

- MM11-E Control Logic

M1091

- Device Select

M7290

- Control Logic & Timing

MM11-E

- 4K Single Memory Unit

MM11-EX

- 4K Interleaved

MM11-F

- 4K Single Memory Unit

MM11-FP

- Single Parity Memory Unit

MM11-FX

- Interleaved Memory (jumpers)

REVISION DATE APRIL /76

MM11-E MEMORY		ETCH	OPTION	OPTION SERIAL #	PDP	SYSTEM SERIAL #	LOCATION	CAB	BOX	SYS. UNIT	SLOT	IPB	PAGE 1 OF 2
ECO	RELEASE DATE	CS	ETCH WL	ECO HRS. TIME	QUICK CHECK CAUTION - NOT COMPLETE ECO		QTY	PARTS REQUIRED	MAINDECS REQUIRED	PRINT SET UPDATE	ACTUAL INSTALL TIME	DATE INSTALLED	CE NAME
00002	01/70		A		Jumper D01-B1 to E01-E1			NIL					
00003	01/70				Black wire of twisted pair from C02-C2 to E03-C2			NIL					
00006	02/70		B		Jumper A01-S2 to A04-S2			NIL					
C 00015	09/70		C		<u>NOTE:</u> 1) Rework multiple box systems only 2) Must have ECO 5408475-00006 and M930-00001 Jumper A03-S2 to B04-F2			NIL					
C 00016	12/70			1.5	Blue jumper from E01-C1 to E01-E2 looping through logic			NIL					
C 00017	01/71		D		Jumper B04-F1 to A03-R2			NIL					
C 00020	03/71				<u>NOTE:</u> F/S information regarding strobe and threshold level settings			NIL					
D 00022	04/71			1.0	A module protection plate along MM11-E memory bank		1	74-08490					
B 00024	06/72		E	1.0	<u>NOTE:</u> Must have ECO M729 #3 Black wire of twisted pair from E01-C2 to F01-C2.			NIL					

EVEN

000

m5

MM11-E		MEMORY		ETCH	OPTION	OPTION SERIAL #	PDP	SYSTEM SERIAL #	LOCATION	CAB	BOX	SYS. UNIT	SLOT	IPB	PAGE 2 OF 2
ECO	RELEASE DATE	CS	ETCH WL	ECO HRS. TIME	QUICK CHECK CAUTION - NOT COMPLETE ECO			QTY	PARTS REQUIRED	MAINDECS REQUIRED	PRINT SET UPDATE	ACTUAL INSTALL TIME	DATE INSTALLED	CE NAME	
00025	05/76				NOTE: Documentation change				NIL						

MM11-F 4K 16 BIT MEMORY		ETCH	OPTION	OPTION SERIAL #	PDP	SYSTEM SERIAL #	LOCATION	CAB	BOX	SYS. UNIT	SLOT	IPB	PAGE 1 OF 1
-------------------------	--	------	--------	-----------------	-----	-----------------	----------	-----	-----	-----------	------	-----	----------------

ECO	RELEASE DATE	CS	ETCH WL	ECO HRS. TIME	QUICK CHECK CAUTION - NOT COMPLETE ECO	QTY.	PARTS REQUIRED	MAINDECS REQUIRED	PRINT SET UPDATED	ACTUAL INSTALL TIME	DATE INSTALLED	CE NAME
D 00001	3/72			1.0	A module protection plate along each MM11-F bank.	1	74-08490					
00002	5/72				<u>NOTE:</u> Print update of test procedure		Nil					
C 00003	8/72		A	1.0	<u>NOTE:</u> Must have ECO M7290-C0003 Red jumper C01-C2 to E01-T1		Nil					

EVEN

ODD

G102 SENSE INHIBIT CARD				ETCH	OPTION	OPTION SERIAL #	PDP	SYSTEM SERIAL #	LOCATION	CAB	BOX	SYS. UNIT	SLOT	IPB	PAGE 1 OF 1
ECO	RELEASE DATE	CS	ETCH WL	ECO HRS. TIME	QUICK CHECK CAUTION - NOT COMPLETE ECO			QTY	PARTS REQUIRED	MAINDECS REQUIRED	PRINT SET UPDATED	ACTUAL INSTALL TIME	DATE INSTALLED	CB NAME	
00001	3/70		C		<u>NOTE:</u> Documentation change				Nil						
B 00002	3/70	B	D	0.5	E5 is a DEC I.C. 74H01-1 E5 is the 1st I.C. from AS1			1	19-09849						
B 00003	4/70	B	D		<u>NOTE:</u> Supplement to ECO # 2 R4 is a 75 ohm 1/8W resistor R4 is the 1st resistor from AA1			8	13-03064						
C 00004	6/70	C	D	.5	R2 is a 56 ohm 1/4W 5% resistor R2 is the 1st resistor above E2 E2 is a DEC transformer			4 4 1	10-00027 13-09995-0 16-09996-0						
00005	6/71		D		<u>NOTE:</u> See ECO # B6				Nil						
B 00006	4/71	D	D	.25	C3 is a 120 MMF 5% capacitor C3 is the closest capacitor from AA1			4	10-00018						
00007	06/77	E	D		<u>NOTE:</u> 1) PHASE IN DEC 7438 TO REPLACE 74H01-1 AT E5 2) CHANGES FCO #2 E5 IS A DEC 7438 E5 IS THE LAST I.C. FROM AS1			1 OR 1	19-0949-00 19-11219-01 (SEE ECO #7)						

3103 MEMORY LEVELS & GATES				ETCH	OPTION	OPTION SERIAL #	PDP	SYSTEM SERIAL #	LOCATION	CAB	BOX	SYS UNIT	SLOT	IPB	PAGE 1 OF 1
ECO	RELEASE DATE	CS	ETCH WL	ECO HRS. TIME	QUICK CHECK CAUTION - NOT COMPLETE ECO			QTY.	PARTS REQUIRED	MAINDECS REQUIRED	PRINT SET UPDATED	ACTUAL INSTALL TIME	DATE INSTALLED	CE NAME	
00001	1/70	A	A		<u>NOTE:</u> Print update				N/A						
C 00002	3/70	B	A	.5	E2 is a I.C. DEC 74H10 E2 is the 1st i.c. from AH1			3	19-09057						
00003	3/70		A		<u>NOTE:</u> Print update				Nil						
C 00004	4/70	C	A	.25	R17 is a 500 ohm trim pot R17 is located in bottom left corner			1	13-05631						
C 00005	6/70	D	A	1.0	R1, R2 are <u>56</u> ohm, 1/4W, 5% resistors R1 & R2 are the two resistors just right of R4 R4 is the 10W resistor nearest the top right corner			2 2 1 2 1 1 1 1	13-02602 13-09994-0 13-00295 10-00027 11-09991 11-09990 16-09996-0 12-100001-0						
00006	2/71	E	A		<u>NOTE:</u> Print change				Nil						
C 00007	1/72	F	A	.25	C11 is a <u>.22</u> mfd 50V capacitor C11 is the only capacitor left of the two transistors at AC1			1	10-10274						

G225 X - Y CURRENT GENERATOR				ETCH	OPTION	OPTION SERIAL #	PDP	SYSTEM SERIAL #	LOCATION	CAB	BOX	SYS UNIT	SLOT	IPB	PAGE		
															1	OF	1
ECO	RELEASE DATE	CS	ETCH WL	ECO HRS. TIME	QUICK CHECK CAUTION - NOT COMPLETE ECO			QTY.	PARTS REQUIRED	MAINDECS REQUIRED	PRINT SET UPDATED	ACTUAL INSTALL TIME	DATE INSTALLED	CE NAME			
C 00003	7/70	B	B	1.0	R22 is a 2.2K 1/4W 5% resistor R22 is the 3rd resistor from bottom left corner			1	13-00417								
00004	7/70	C	C		R5 is a 680 ohm 1/4W 5% resistor R5 is the 1st resistor from A1			4	12-02313								
								4	13-00347								
								4	13-00394								
00005	8/70	C			<u>NOTE:</u> Print change				Nil								
00006	9/70	D	D		<u>NOTE:</u> New etch rev				Nil								
C 00007	5/71	E	D	1.0	<u>NOTE:</u> Rework only "D" etch boards Insulating washers on all four heat sinks are tight and can not be rotated.			4	90-08493 90-08268 (thermal compound)								

G226 X - Y DECODER SWITCH		ETCH	OPTION	OPTION SERIAL #	PDP	SYSTEM SERIAL #	LOCATION	CAB	BOX	SYS. UNIT	SLOT	IPB	PAGE 1 OF 1
ECO	RELEASE DATE	CS	ETCH WL	ECO HRS. TIME	QUICK CHECK CAUTION - NOT COMPLETE ECO		QTY	PARTS REQUIRED	MAINDECS REQUIRED	PRINT SET UPDATED	ACTUAL INSTALL TIME	DATE INSTALLED	CE MAX
00001	11/69	A	C		C22 is a .1ufd 50V capacitor C22 is below the two 1/4W resistors on board which are separated by a capacitor			N/A					
00002	3/70	B	C		NOTE: Documentation			Nil					
00003	3/70	C	C		Resistor closest to the bottom left corner is a 120 ohm 1/4W 5% resistor			N/A					
C 00004 8A 63	11/71	D	D	0.5	C22 is a .22 ufd 50V capacitor C22 is below the two 1/4W resistors on board which are separated by a capacitor		1	10-10274					

EVEN

ODD

REVISION DATE DEC/75

M109		DEVICE SELECT		ETCH	OPTION	OPTION SERIAL#	PDP	SYSTEM SERIAL #	LOCATION	CAB	BOX	SYS. UNIT	SLOT	IPB	PAGE 1 OF 1
ECO	RELEASE DATE	CS	ETCH WL	ECO HRS. TIME	QUICK CHECK CAUTION - NOT COMPLETE ECO			QTY	PARTS REQUIRED	MAINDECS REQUIRED	PRINT SET UPDATE	ACTUAL INSTALL TIME	DATE INSTALLED	CE NAME	
NONE					NOTE: NO ECO's										

EVEN

000

66

M729		MM11-E Control Logic		ETCH	OPTION	OPTION SERIAL#	PDP	SYSTEM SERIAL #	LOCATION	CAB	BOX	SYS. UNIT	SLOT	IPB	PAGE 1 OF 1
ECO	RELEASE DATE	CS	ETCH WL	ECO HRS. TIME	QUICK CHECK CAUTION - NOT COMPLETE ECO			QTY	PARTS REQUIRED	MAINDECS REQUIRED	PRINT SET UPDATE	ACTUAL INSTALL TIME	DATE INSTALLED	CE NAME	
00001	03/70	A	B		<p><u>NOTE:</u> 1) New etch rev 2) Rework Etch "A" Revs E5 is aDEC I.C. 74 H 74</p>				N/A						
B 00002	01/71	B	C	1.0	<p><u>NOTE:</u> 1) Must be installed in interleaved memories and optional for non-interleaved memory 2) Rework etch "B" rev only (ECO #3 has better rework instructions) No capacitor between the 270 OHM and 390 OHM resistors located near the upper left hand corner</p>				NIL						
C 00003 6A 6B	06/72 01/73	C	C	1.5	<p><u>NOTE:</u> ECO# 3 contains ECO #2 & #3 rework instructions for all etch revs Measure an open CKT from E04-09 to E09-01 E09 is the 4th I.C. from AK1</p>			1	19-05547	DZQGQ DZQCA DZQKB					

EVEN

H6

M1091 DEVICE SELECT		ETCH	OPTION	OPTION SERIAL #	PDP	SYSTEM SERIAL #	LOCATION	CAB	BOX	SYS UNIT	SLOT	IPB	PAGE		
													1	OF	1
ECO	RELEASE DATE	CS	ETCH WL	ECO HRS. TIME	QUICK CHECK CAUTION - NOT COMPLETE ECO		QTY.	PARTS REQUIRED	MAINDECS REQUIRED	PRINT SET UPDATED	ACTUAL INSTALL TIME	DATE INSTALLED	CE NAME		
C 00001	3/71	*	A	N/A	NOTE: MM11-E systems M1091 module if 16K of memory or more		1	M1091 etch "B" (if applicable)							
00002	3/71	A	B		NOTE: MM11-E, MM11-F and MMR11-E memory systems phase in M1091 modules. Check for M1091 module		1	M1091 Etch "B"							

M7290 CONTROL AND LOGIC				ETCH	OPTION	OPTION SERIAL #	PDP	SYSTEM SERIAL #	LOCATION	CAB	BOX	SYS. UNIT	SLOT	IPB	PAGE 1 OF 1
ECO	RELEASE DATE	CS	ETCH WL	ECO HRS. TIME	QUICK CHECK CAUTION - NOT COMPLETE ECO			QTY	PARTS REQUIRED	MAINDECS REQUIRED	PRINT SET UPDATED	ACTUAL INSTALL TIME	DATE INSTALLED	CE NAME	
00001	2/71	C	D		Jumper E06-06 to E31-10 feed through E6 is the 3rd I.C. from AL1 E31 is the last I.C. on board				Nil						
C 00002	9/71	D	E D C	2.0	NOTE: Rework "C" & "D" etch boards Jumper E03-03 to T07-10 feed through				Nil						
C 00003	8/72	E	F E D C	4.0	NOTE: 1) Must have ECO MM11-F-C0003 2) Rework all previous etch boards Jumper E02-08 to AC1				Nil	DZMMA thru DZMMI					
00004	/77	F	F E D C		NOTE: DEC 74H01-1 DIRECT SUBSTITUTION TO DEC 7438 E IS A DEC 7438 E IS				NIL						

MM11-F

DOL

digital EQUIPMENT CORPORATION
MAYNARD MASSACHUSETTS

Engineering Change
Order Log
DEC O LOG

MM11-F

4K 16 Bit
22 Mil Memory

2356 R624

PROCESSOR TYPE PDP-11

MM11F-00001 CODE: DF ML: A
MAR 72 PROBLEM Under some conditions, when other options are placed along side an MM11F they fail to operate correctly
CORRECTION Install a module protection plate
In plant effectivity All MM11F as required
Field effectivity All MM11F as required
(Time To Install And Test 16 Hours)
(Kit Contents FCO Prints And Parts)

MM11F-00002 CODE: P ML: B
APR 72 PROBLEM 1 MM11F Test Procedure needs updating
CORRECTION 1 Update Test Procedure
PROBLEM 2 MM11FX print sets are the same as MM11F
CORRECTION 2 Obsolete old MM11FX Master Drawing 1st Use New Master Drawing 1st format on MM11F to include MM11FX
In plant effectivity 06 documentation change only

MM11F-00003 CODE: F ML: D WL: A
MAY 72 PROBLEM 1 Strobe signals and TISH have too much noise on them
CORRECTION 1 Install twisted pairs on strobe signals, generate another TISH signal and install twisted pairs on these signals
PROBLEM 2 READ H signal has too many loads on it
CORRECTION 2 Develop another READ H signal to share the load
CORRECTION 3 Solves memory problems caused by DMA transfers that memory diagnostics don't show up. Also solves slot sensitive G101, G102 problems
In plant effectivity Rework immediately
Field effectivity Retrofit all MM11F
(Time To Install And Test 10 Hour)
(Kit Contents FCO Prints)

PAGE 1

JUN 7 '976

EVEN

000

67

FCCO'S



ENGINEERING
CHANGE ORDER 8521

ORIGINATOR Richard Manion 5-2
TEL EXT 2005 DATE 3/13/72
DISC PROJ NO. 11 07602
COST CENTER NO. 392

J.S.

ECO NO. MM11F-0001
SHEET 1 OF 3
DATE RECEIVED 3-16-72
FIRST ISSUE 3-20-72
FINAL ISSUE

PROBLEM
Under some conditions when other options are placed along side an MM11/F they fail to operate correctly.

UNIT TO BE CHANGED

MM11/F
Memory

DISP CODE *

OPTIONS AFFECTED

MM11/F

CORRECTION

Install a module protection plate.

BREAK-IN/EFFECTIVITY

*Install module protection plate only when problems occur.

PRODUCT LINES
AFFECTED

PDP11/20

ITEM NO.	DOCUMENT/PART NO.	OLD REV	NEW REV	DISP CODE	DESCRIPTION OF CHANGE	DOCUMENTATION AFFECTED	FIELD SERVICE AFFECTED	TYPE OF CHANGE
1.	A-PL-MM11-F-0	0	A	06	(Memory Assembly MM11/F) Change per this ECO.	<input type="checkbox"/> MODEL <input type="checkbox"/> DIAGNOSTICS <input type="checkbox"/> TECH MANUAL <input type="checkbox"/> TESTER <input type="checkbox"/> TEST PROG <input type="checkbox"/> TOOLING <input type="checkbox"/> PKG INST <input type="checkbox"/> ENG SPEC <input type="checkbox"/> PURCH SPEC	<input checked="" type="checkbox"/> YES <input type="checkbox"/> NO <input type="checkbox"/> Customer Charge <input checked="" type="checkbox"/> Product Line Change	<input type="checkbox"/> ELECTRICAL <input checked="" type="checkbox"/> MECHANICAL <input type="checkbox"/> MODULE
2.	7408490	-	-	07	(Module Protection Plate) Add quantity of 1 to drawing index.			
3.	A-ML-MM11-F	0	A	06	Update per item 1.			ORDER PR MODEL <input type="checkbox"/> YES <input checked="" type="checkbox"/> NO

DISPOSITION CODES

APPROVAL SIGNATURES

00 - RETURN TO STOCK
01 - (DELETED)
02 - USE PRESENT STOCK UNTIL NEW STOCK AVAILABLE (PHASE IN)
03 - REWORK IMMEDIATELY (RETROFIT)
04 - (DELETED)
05 - (DELETED)
06 - DOCUMENT CORRECTION
07 - NEW ITEM (THIS ASSEMBLY)
08 - NEW ITEM (THIS COMPANY)
09 - SCRAP IMMEDIATELY

Type-written Initial Signature
DESIGN ENGR Pete Durant *Pete Durant*
ENC MGR (OPT) _____
FIELD SERVICE (OPT) _____
CHIEF ENGR (MODULES ONLY) *P.D.*

ECO MMIF
MMIF REWORK SHEET

SHEET 2 OF 3

1. LOOSEN 2 SCREWS AT POINTS A, CARE SHOULD BE USED AT ALL TIME SO THAT NO WIRES WILL BE DAMAGED.
2. SLIDE THE FINGERS OF THE MODULE PROTECTION PLATE UNDER THE END LUGS. THE PROTECTION PLATE SHOULD BE RIGHT AGAINST THE WIRED ASSY. FRAME, POINTS B.
3. TIGHTEN SCREWS.

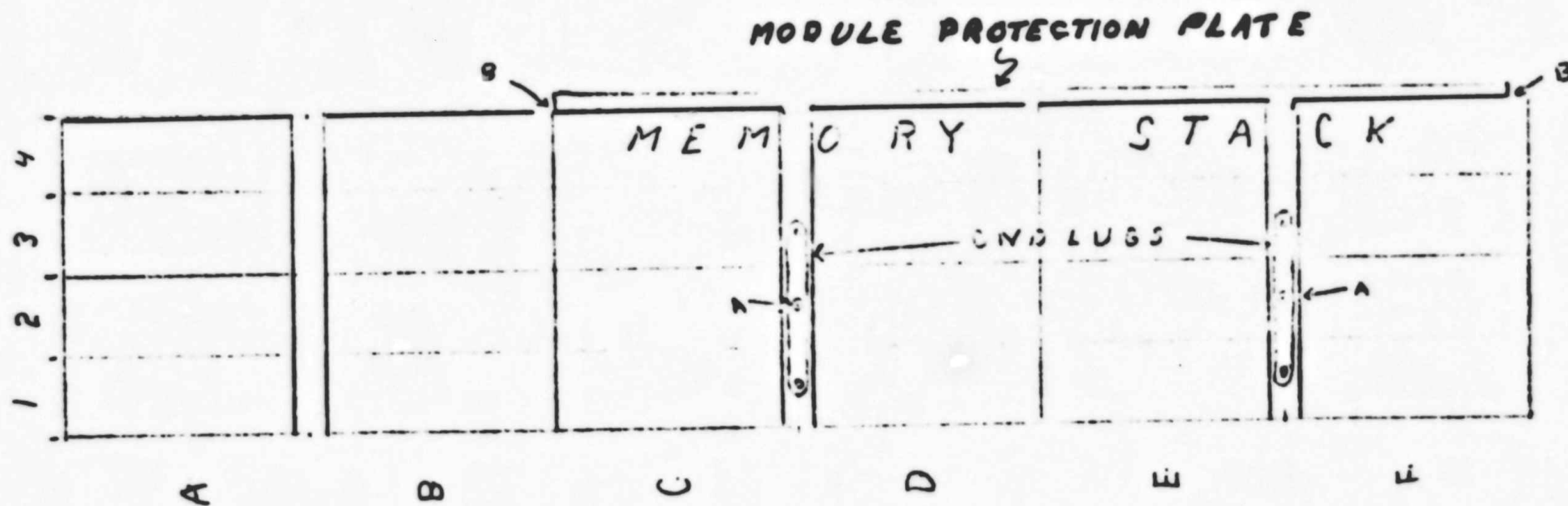



FIELD CHANGE ORDER

FCO MM11F - D 0001PAGE 1 OF 3

DATA PROCESSING AND DEC-ECO-LOG WILL POST THIS FCO WITH THE LEVEL OF URGENCY CODE REPLACING THE LEADING ZERO.

FIELD EFFECTIVITY
MM11-P Memory AssemblyFIELD RETROFIT IS ANTICIPATED IN 5 % OF UNITS DEFINED ABOVE NO CHARGE TO CUSTOMER - ALL DEC INSTALLATION LABOR AND MATERIAL ARE TO BE REPORTED UNDER A "W" CHARGE CODE. STANDARD APPLICABILITY - THIS FCO IS TO BE INSTALLED AT NO CHARGE FOR WARRANTY AND MAINTENANCE CONTRACT CUSTOMERS IN ACCORDANCE WITH THE TECHNICAL EFFECTIVITY ABOVE, OTHERWISE AT CUSTOMER EXPENSEDOCUMENTATION 8 PARTS 8 DEC ON-SITE LABOR 8

DEC'S MINIMUM BILLING APPLIES IF THIS FCO IS INSTALLED BY DEC. THE DEC LABOR CHARGE ASSUMES FCO INSTALLATION DURING REGULAR WORKING HOURS. IF INSTALLATION OUTSIDE OF REGULAR WORKING HOURS IS ORDERED, DEC'S LATEST SCHEDULE OF HOURLY RATES WILL APPLY.

FIELD OFFICE FCO DISTRIBUTION CODE F IMMEDIATE FCO DISTRIBUTION TO ALL DEC FIELD OFFICES DF IMMEDIATE FCO DISTRIBUTION TO REGIONAL PRODUCT SUPPORT AND TO OFFICES WHERE SUBJECT EQUIPMENT IS LOCATED.**FCO KIT DISTRIBUTION** FSIC WILL INITIATE DISTRIBUTION OF FCO KITS AS DEFINED BELOW IN ACCORDANCE WITH THE EDP CONFIGURATION FILE. ~~Field Installation Orders (FIAs) will be distributed~~ KITS, AS DEFINED BELOW MAY BE ORDERED AS REQUIRED.**CONTENTS OF AN FSIC INITIATED KIT**

FIO	FCO	PRINTS	PARTS

CONTENTS OF A FIELD ORDERED KIT

FIO	FCO	PRINTS	PARTS
	X	X	X

FSIC INITIATED FCO KITS WILL BE DISTRIBUTED FOR ALL UNITS LISTED ON THE EDP CONFIGURATION FILE WITH THE FOLLOWING SERVICE STATUS CODES:

D	H	A	W		
---	---	---	---	--	--

 PRINT CHANGES ARE MINOR AND ARE TO BE MADE MANUALLY IN RED AND GREEN. FCO REVISED PRINTS WILL BE SUPPLIED ONLY UPON SPECIAL REQUEST.**INSTALLATION AND TEST PROCEDURES**

- Carefully install module protection plate per FCO instructions. This requires insertion of the plate under existing wire runs which can be easily broken.
- Run maindecs or other programs whose failure indicated the need for this FCO to be implemented. They should now function correctly.

NOTESFIELD SERVICE APPROVAL
Charles Dewey**LEVEL OF URGENCY CODE**

- A MANDATORY - HIGH PRIORITY
- B MANDATORY
- C HIGH PRIORITY IF SPECIFIC HARDWARE, SOFTWARE, OR SYMPTOMS ARE PRESENT
- D APPLICABLE IF SPECIFIC HARDWARE, SOFTWARE, OR SYMPTOMS ARE PRESENT
- E PRODUCT IMPROVEMENT - OPTIONAL - LOW PRIORITY

DISCRETE PROJECT NUMBER (FOR FIELD SERVICE REPORTING)

AVAILABILITY DELAY	NO PARTS
PARTS <u>None</u>	

ESTIMATED DOWN TIME FOR INSTALLATION AND TESTING 1.0 HOURS

SPECIAL TEST EQUIPMENT, TOOLS, OR SUPPLIES

LAST PREVIOUS FCO'S None

RELATED OR PREREQUISITE FCO'S

- MAINDEC CHANGE
- MAINTENANCE MANUAL CHANGE
- OPERATIONAL PROGRAMS AFFECTED

VERIFICATION MAINDECS

PARTS REQUIRED
Q' 74-08490 Module Protection Plate

THIS DOCUMENT WAS NOT PRODUCED FOR MICROFICHE; THEREFORE, ONLY PARTS OF IT ARE READABLE.

3/20 3/24 (D) 3/24 75

digital

ENGINEERING
CHANGE ORDER #9648

ORIGINATOR Richard Manion
TEL EXT 2005 DATE 5/10/72
DISC PROJ NO. 96 06122
COST CENTER NO. 392

ECO NO. MM11F-00003
SHEET 1 OF
DATE RECEIVED 5-12-72
FIRST ISSUE 5-15-72
FINAL ISSUE 8-4-72

PROBLEM

1. Strobe signals and TINH have too much noise on them.
2. Read H signal has too many loads on it.
3. Solves memory problems caused by DMA transfers that memory diagnostics don't show up, also, solves slot sensitive G103, G102 problems.

UNIT TO BE CHANGED

MM11/F

DISP CODE 03

OPTIONS AFFECTED

MM11/F

CORRECTION

1. Install twisted pairs on strobe signals, generate another TINH signal and install twisted pairs on these signals.
2. Develop another Read H signal to share the load.

BREAK-IN/EFFECTIVITY

All MM11/F's shipped after May 31 will have this ECO.
Rework M7290 module when necessary, all MM11/F's with this ECO have to have M7290's with ECO #3.

PRODUCT LINES AFFECTED

PDP11/15
PDP11/20
PDP11/45

ITEM NO.	DOCUMENT/PART NO.	OLD REV	NEW REV	DISP CODE	DESCRIPTION OF CHANGE
1.	K-WL-MM11-F-07	-	A	06	Update wire list.
2.	A-PL-MM11-F-0	A	B	06	Update Rev. per this ECO.
3.	A-ML-MM11-F	C	D	06	Update.
4.	D-AD-7007263-0-0	-	A	06	Wire Ass'y MM11/F. See final release print.
5.	D-BS-MM11-F-03	-	A	06	Core memory stack (2 sheets) See final release print.
6.	A-PL-7007263-0-0	-	A	06	Update revision level.

DOCUMENTATION AFFECTED

- MODEL
- DIAGNOSTICS
- TECH MANUAL
- TESTER
- TEST PROG
- TOOLING
- PKG INST
- ENG SPEC
- PURCH SPEC

FIELD SERVICE AFFECTED

- YES NO
- Customer Charge
- Product Line Charge

TYPE OF CHANGE

- ELECTRICAL
 - MECHANICAL
 - MODULE
- ORDER PR MODEL
- YES
 - NO

DISPOSITION CODES

- 00 - RETURN TO STOCK
- 01 - (DELETED)
- 02 - USE PRESENT STOCK UNTIL NEW STOCK AVAILABLE (PHASE IN)
- 03 - REWORK IMMEDIATELY (RETROFIT)
- 04 - (DELETED)
- 05 - (DELETED)
- 06 - DOCUMENT CORRECTION
- 07 - NEW ITEM (THIS ASSEMBLY)
- 08 - NEW ITEM (THIS COMPANY)
- 09 - SCRAP IMMEDIATELY

APPROVAL SIGNATURES

Typewritten / Hand Signature

DESIGN ENGR Pete Durant / *P. Durant*

ENG MGR (OPT) _____

FIELD SERVICE (OPT) _____

CHIEF ENGR (MODULES ONLY) _____

digital

ENGINEERING CHANGE ORDER
ADD/DELETE SHEET

ECO NO.
MM11F-00003
Sheet ___ of ___

WIRE LIST NO. K-WL-MM11-F-07

TITLE
MM11/F WIRE LIST
NEW REV. A

MAKE ALL DELETIONS FIRST WHEN INSTALLING

SIGNAL NAME	FROM PIN	TO PIN	COMPONENTS	ADD	DEL
TINH H	C01C1	D02E1			X
TINH H	D03E1	E03E1			X
TINH H	E01E1	F01E1			X
STROBE 0 H	C01R1	D02S1			X
STROBE 01 H	C01R1	E01S1			X
TSS H	F01V2	F01P1			X
TINH L	C01K1	F01S1		X	
TINH L	F01S1	F01U2		X	
TINH L	F01U2	F01V2		X	
TINH 0 H	C01C1	D02E1	WHT	TWP	X
GND	C01C2	D02C2	RED		X
TINH 01 H	F01T2	F01F1	WHT	TWP	X
GND	F01T1	F01C2	RED		X
TINH 01 H	F01T2	E02E1	WHT	TWP	X
GND	F01T1	E02C2	RED		X
STROBE 0 H	C01R1	D02S1	WHT	TWP	X
GND	C01T1	D02T1	RED		X
STROBE 01 H	C01R1	E01S1	WHT	TWP	X
GND	C01C2	E01T1	RED		X

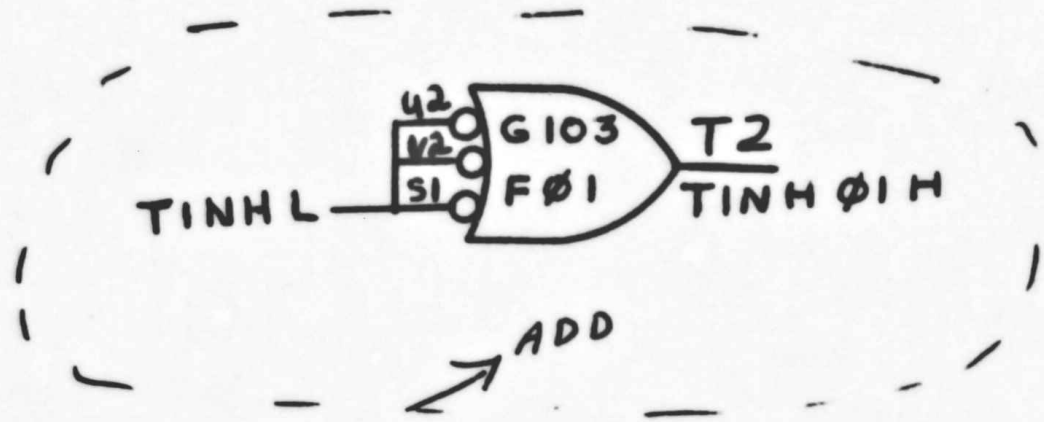

digital

ENGINEERING
CHANGE ORDER

CORE
MEMORY STACK
TITLE (X DRIVE)

DATE *Alice Husted*

NO. 1

ECO NO. D-05-MM11-F-03

B-7

GLX

REV A

GRAPHIC
DESCRIPTION

shn 3

000

WIRE TABLE

SIGNAL NAME	FROM PIN	TO PIN	COLOR	REMARKS	NAME SIGNAL	FROM PIN	TO PIN	COLOR	REMARKS
-15	A03L1	F04B2	↓ BLU	WIRES MUST PHYSICALLY RUN TO THE RIGHT OF THE BLK AND PINS					
TINN P/H GND	C01C1 C01C2	D02E1 D02C2	WHT BLK	TWP					
TINN P/H GND	F01T2 F01T1	F01F1 F01B2	WHT BLK	TWP	SAIB SAIB LNH1B	D04Y1 D04Y2 D04V2	GND G03J2 G03J1	WHT BLK YEL	3 TWISTED WIRES
					STROBE B GND	C01K1 C01T1	D02S1 D02T1	WHT BLK	TWP
					STROBE B1 GND	C01A1 C01C2	E01S1 E01T1	WHT BLK	TWP
									→ ADD

digital

WIRED ASSY
M M 11-15

DWG NO. DAD-707263-0-0 NEW A

ENGINEERING
CHANGE ORDER

DRN *W. J. ...*

GRAPHIC
DESCRIPTION

digital

FIELD CHANGE ORDER

4866

FCO MM11P-C 0003
PAGE OF

DATA PROCESSING AND DEC-ECO-LOG WILL POST THIS FCO WITH THE LEVEL OF URGENCY CODE REPLACING THE LEADING ZERO.

FIELD EFFECTIVITY
Retrofit all MM11-F's

- * LEVEL OF URGENCY CODE
- A MANDATORY - HIGH PRIORITY
 - B MANDATORY
 - C HIGH PRIORITY IF SPECIFIC HARDWARE, SOFTWARE, OR SYMPTOMS ARE PRESENT
 - D APPLICABLE IF SPECIFIC HARDWARE, SOFTWARE, OR SYMPTOMS ARE PRESENT
 - E PRODUCT IMPROVEMENT - OPTIONAL - LOW PRIORITY

FIELD RETROFIT IS ANTICIPATED IN 100% OF UNITS DEFINED ABOVE

- NO CHARGE TO CUSTOMER - ALL DEC INSTALLATION LABOR AND MATERIAL ARE TO BE REPORTED UNDER A "W" CHARGE CODE.
- STANDARD APPLICABILITY - THIS FCO IS TO BE INSTALLED AT NO CHARGE FOR WARRANTY AND MAINTENANCE CONTRACT CUSTOMERS IN ACCORDANCE WITH THE TECHNICAL EFFECTIVITY ABOVE, OTHERWISE AT CUSTOMER EXPENSE.
- DOCUMENTATION PARTS DEC ON-SITE LABOR
- DEC'S MINIMUM BILLING APPLIES IF THIS FCO IS INSTALLED BY DEC. THE DEC LABOR CHARGE ASSURES FCO INSTALLATION DURING REGULAR WORKING HOURS. IF INSTALLATION OUTSIDE OF REGULAR WORKING HOURS IS ORDERED, DEC'S LATEST SCHEDULE OF HOURLY RATES WILL APPLY.

DISCRETE PROJECT NUMBER
(FOR FIELD SERVICE REPORTING)

AVAILABILITY DELAY	NO PARTS
PARTS	X

ESTIMATED DOWN TIME FOR INSTALLATION AND TESTING 1.0 HOURS

SPECIAL TEST EQUIPMENT, TOOLS, OR SUPPLIES

FIELD OFFICE FCO DISTRIBUTION CODE

- F IMMEDIATE FCO DISTRIBUTION TO ALL DEC FIELD OFFICES
- DF IMMEDIATE FCO DISTRIBUTION TO REGIONAL PRODUCT SUPPORT AND TO OFFICES WHERE SUBJECT EQUIPMENT IS LOCATED.

FCO KIT DISTRIBUTION

- PSIC WILL INITIATE DISTRIBUTION OF FCO KITS AS DEFINED BELOW IN ACCORDANCE WITH THE EDP CONFIGURATION FILE.
- ~~PSIC WILL INITIATE DISTRIBUTION OF FCO KITS AS DEFINED BELOW IN ACCORDANCE WITH THE EDP CONFIGURATION FILE.~~ KITS, AS DEFINED BELOW, MAY BE ORDERED AS REQUIRED.

CONTENTS OF AN PSIC INITIATED KIT

FIG	FCO	PRINTS	PARTS

PSIC INITIATED FCO KITS WILL BE DISTRIBUTED FOR ALL UNITS LISTED ON THE EDP CONFIGURATION FILE WITH THE FOLLOWING SERVICE STATUS CODES:

CONTENTS OF A FIELD ORDERED KIT

FIG	FCO	PRINTS	PARTS
	X	X	

D H K W

- PRINT CHANGES ARE MINIMAL AND ARE TO BE MADE MANUALLY IN RED AND GREEN FCO REVISED PRINTS WILL BE SUPPLIED ONLY UPON SPECIAL REQUEST.

INSTALLATION AND TEST PROCEDURES

LAST PREVIOUS FCO'S D01

RELATED OR PREREQUISITE FCO'S
M7290-00003

- MAINDEC CHANGE
- MAINTENANCE MANUAL CHANGE
- OPERATIONAL PROGRAMS AFFECTED

VERIFICATION MAINDECS

PARTS REQUIRED

NOTES

Necessary to improve reliability on existing units.

FIELD SERVICE APPROVAL

Art Zins

24K
5/16 5/17 (171) 5/18 400

THIS DOCUMENT WAS NOT PRODUCED FOR MICROFICHE; THEREFORE, ONLY PARTS OF IT ARE READABLE.

FCR

AT

**MM11-F
4K 16 BIT 22 MIL MEMORY
FCO Cross Reference**

**A Chronological Listing of Field Retrofit FCO's Which Must Be
Considered in the Field Installation and Maintenance of This Option/Module/Power Supply**

• Indicates FCO Conjunction Must Be Considered With Prior FCO

- 1 **G102-B0002 MAR 70**
G102-B0003
QUICK SYNOPSIS
8881 IC's replaced by higher speed 74H011 IC's.
QUICK CHECK
74H011 IC's in place of 8881 IC's
NEW REVISION
Exchange with CS B or later.
- 2 **G103-C0002 MAR 70**
QUICK SYNOPSIS
Increases system speed.
QUICK CHECK
7410 IC replaced by 74H10.
NEW REVISION
Rework etch B, C to CS B.
- 3 **G103-C0004 APR 70**
QUICK SYNOPSIS
Provides new higher value trimpot.
QUICK CHECK
R17 changed from 100 ohm to 500 ohm trimpot
NEW REVISION
Rework etch B, C to CS C.
- 4 **G102-B0004 JUN 70**
QUICK SYNOPSIS
Decreases Turn-off time of the 2007 transistors.
QUICK CHECK
C2, C7, C12, C17, changed from 1000mmfd to 820mmfd.
NEW REVISION
Rework etch D to CS D.
- 5 **G103-C0005 JUN 70**
QUICK SYNOPSIS
Provides increase to -6.84VDC for Sense amplifiers
QUICK CHECK
Heat sink ADD'ed to Q4. C1 and C2 changed from 1000mmfd to 820mmfd.
NEW REVISION
Rework etch D, E to CS D.
- 6 **G225-C0003 JUL 70**
QUICK SYNOPSIS
Speeds stabilization of X and Y current generator reference voltage.
QUICK CHECK
R22 changed from 4.7K ohm to 2.2K ohms
NEW REVISION
Rework etch B to CS B.
- 7 **M930-C0001 AUG 70**
QUICK SYNOPSIS
Power Fail requires BUS SP1 and BUS SP2 for AC LO and DC LO (In-plant, new etch B at CS A.)
QUICK CHECK
R57 and R69 are 390 ohms
NEW REVISION
Exchange with etch B.
- **5408475-C0006 OCT 70**
QUICK SYNOPSIS
AC LO and DC LO return high after assertion in multiple box systems
QUICK CHECK
D003 clamping diode from AC LO (anode) and from DC LO to +5V line
NEW REVISION
Rework etch A, B, C to CS D.
- 8 **M729-C0002 JAN 71**
QUICK SYNOPSIS
Reduces memory cycle time on systems with 8K interleaved memory (In-plant, new etch C.)
QUICK CHECK
Wire ADD E9 pin 2 to feed-thru near E5 pin 1
NEW REVISION
Rework etch B to CS B.

**MM11-F
4K 16 BIT 22 MIL MEMORY
FCO Cross Reference**

**A Chronological Listing of Field Retrofit FCO's Which Must Be
Considered in the Field Installation and Maintenance of This Option/Module/Power Supply**

• Indicates FCO Conjunction Must Be Considered With Prior FCO

- 9 M1091-C0001 MAR 71**
QUICK SYNOPSIS
Provides 1 unit load on BUS in systems with
16K or more memory.
QUICK CHECK
M1091 replaces M109 module.
NEW REVISION
Rework etch B to CS A.
- 10 G102-B0006 APR 71**
QUICK SYNOPSIS
Eliminates MM11-F's noise susceptibility.
QUICK CHECK
C3, C8, C13, C18 changed from 33mmfd to
120mmfd.
NEW REVISION
Rework etch D to CS D.
- 11 G225-C0007 MAY 71**
QUICK SYNOPSIS
Prevent heat sink from shorting to etch
QUICK CHECK
Insulating washers under heat sinks.
- 12 M7290-C0002 OCT 71**
QUICK SYNOPSIS
Prevents Unibus hang with SSYN asserted
from memory. (In-plant, new etch E).
QUICK CHECK
Wire ADD E8 pin 5 to E7 pin 9.
NEW REVISION
Rework etch C to CS D.
- 13 MM11F-D0001 MAR 72**
QUICK SYNOPSIS
Module protection plate prevents MM11-F
noise interaction with adjacent modules.
QUICK CHECK
Presence of protection plate.
- 14 MM11F-C0003 MAY 72**
QUICK SYNOPSIS
Reduces noise on TINH and strobe signals
QUICK CHECK
C01C1 to D02E1/C01C2 to D02C2
NEW REVISION
Rework to Wire List A.
- 15 M729-C0003 MAY 72**
M729-D0004
QUICK SYNOPSIS
Unibus hangs with SSYN asserted from
memory
QUICK CHECK
Wire ADD E5 pin 8 to E3 pin 1
NEW REVISION
Rework etch B, C to CS C
- 16 M7290-C0003 MAY 72**
QUICK SYNOPSIS
Reduced inductance of TINH H etch corrects
noise condition. (In-plant, new etch F)
QUICK CHECK
Wire ADD F11 pin 8 to feed-thru going to
AR1
NEW REVISION
Rework etch C, D to CS E

MM11-L

FCR

**MM11-L
8K 16 BIT 16 MIL MEMORY
FCO Cross Reference**

**A Chronological Listing of Field Retrofit FCO's Which Must Be
Considered in the Field Installation and Maintenance of This Option/Module/Power Supply**

• Indicates FCO Conjunction Must Be Considered With Prior FCO

- | | |
|---|--|
| <p>1 G110-B0004 MAY 72
QUICK SYNOPSIS
Corrects Delay line 3 termination on etch C
G110's
QUICK CHECK
R115 changed from 3 K ohms
NEW REVISION
Rework etch C to CS D
COMPATIBILITY
R115 changed from 3K ohms to 1K ohms</p> | <p>1 MM11-S-C0003 OCT 72
QUICK SYNOPSIS
Module protection plate prevents MM11-S
noise interaction with adjacent modules
QUICK CHECK
Presence of module protection plate</p> |
| <p>2 G110-B0005 MAY 72
QUICK SYNOPSIS
Corrects C152 insertion polarity (positive terminal) to +5V
QUICK CHECK
Positive terminal of C152 goes to +5V
NEW REVISION
Rework etch C, D to CS E</p> | <p>2 G110-C0010 NOV 72
QUICK SYNOPSIS
Data errors occur during the first DAT1 to any
memory bank
QUICK CHECK
Wire ADD E28 pin 13 to E15 pin 10
NEW REVISION
Rework etch C, D, E to CS J</p> |
| <p>3 G231-B0001 MAY 72
QUICK SYNOPSIS
Prevents components on G231 shorting to
module above it
QUICK CHECK
Two phenolic 7/16" standoffs on module
NEW REVISION
Rework etch B to CS C</p> | <p>3 G110-D0012 DEC 72
QUICK SYNOPSIS
Provides print clarification affecting etch C
G110's
NEW REVISION
CS E5</p> |
| <p>4 G231-D0003 AUG 72
QUICK SYNOPSIS
Improves -15V and strobe margins when
operating at 55°C
QUICK CHECK
Sixteen D672 diodes replace 330 ohm
resistors
NEW REVISION
Rework etch B to CS F</p> | <p>4 G110-D0013 DEC 72
QUICK SYNOPSIS
Ensures PAL and PBL data bits gate high onto
the BUS
QUICK CHECK
Wire ADD's E40 pin 4 to pin 13 and E40 pin 9
to pin 12
NEW REVISION
Rework etch C to CS E6</p> |
| <p>5 G231-A0005 AUG 72
QUICK SYNOPSIS
Improves DC LO and AC LO circuit operation
QUICK CHECK
Wire ADD from R89 to R93
NEW REVISION
Rework etch C to CS E1</p> | <p>5 G231-D0009 DEC 72
QUICK SYNOPSIS
G231 prints redrawn to DEC standards
NEW REVISION
CS E4</p> |

**MM11-L
8K 16 BIT MIL MEMORY
FCO Cross Reference**

**A Chronological Listing of Field Retrofit FCO's Which Must Be
Considered in the Field Installation and Maintenance of This Option/Module/Power Supply**

• Indicates FCO Conjunction Must Be Considered With Prior FCO

- 11 G109-C0004 DEC 72**
QUICK SYNOPSIS
Replaces +3V with INIT L to reset STROBE one-shot
QUICK CHECK
Wire ADD E28 pin 13 to E15 pin 10
NEW REVISION
Rework etch C, E to CS E3
- 12 G110-C0015 MAR 73**
QUICK SYNOPSIS
Allows longer memory cycle time on systems with high speed NPR devices
QUICK CHECK
DL3 changed from 100nsec to 125nsec delay
NEW REVISION
Rework etch C to CS E7
- 13 G110-CD016**
QUICK SYNOPSIS
Eliminates noise on BUS INIT etch
QUICK CHECK
Wire ADD's E4 pin 4 to E7 pin 7; AA1 feed-thru to E7 pin 6
NEW REVISION
Rework etch C to CS E8
- 14 G109-C0006 MAR 73**
QUICK SYNOPSIS
Lengthens memory cycle time
QUICK CHECK
DL3 replaced with 125nsec delay
NEW REVISION
Rework etch C to CS E4
- 15 G109-C0007 MAR 73**
QUICK SYNOPSIS
Eliminates noise coupling onto BUS INIT etch from data line etches
QUICK CHECK
Wire ADD E4 pin 4 to E7 pin 7
NEW REVISION
Rework etch C to CS E
- 16 G110-B0018 APR 73**
QUICK SYNOPSIS
Eliminates noise on STROBE O H etch
QUICK CHECK
Twisted pair E32 pin 6 feed-thru to E58 pin 4 feed-thru/E33 pin 7 to ground side of C4
NEW REVISION
Rework etch C to CS E9
- 17 G109-C0010 JUL 73**
QUICK SYNOPSIS
Eliminates noise-induced condition where memory randomly picks up and drops bits
QUICK CHECK
E32 pin 6 feed-thru to E58 pin 14 feed-thru/E33 pin 7 to ground side of C44
NEW REVISION
Rework etch C to CS E7
- 18 G110-C0019 NOV 73**
QUICK SYNOPSIS
Widening R/W Reset L prevents memory skipping a restore cycle
QUICK CHECK
E26 pin 8 goes to tap 10 of Delay line
NEW REVISION
Rework etch C to CS E10
- 19 G109-C0011 NOV 73**
QUICK SYNOPSIS
Lengthens R/W flip-flop reset input pulse to prevent skipped memory cycles on a read
QUICK CHECK
E26 pin 8 goes to top 10 of the Delay line
NEW REVISION
Rework etch C to CS E8

ECO
QUICK CHECK

NOV./74

MM11-L PARTS BREAKDOWN

- G110 - Control and Data Loops
- G231 - Memory Driver
- H214 - 8K 16 Bit Memory Stack
- MM11-L - One 8K 16 Bit Bank of Memory

MM11-L FIELD CODED ECO'S

G110	B4, B5, C9, C10 & A, D12, D13 & A, C15 & A, C16, B18, C19
G231	B1, D3, A5, D9

March/75

MM11-L ECO PARTS

<u>NAME</u>	<u>ECO #</u>	<u>QTY</u>	<u>PART NUMBER</u>	<u>COMMENTS & DESCRIPTION</u>
G110	#4	1	13-00365	Resistor
	#5	1	10-05306	Capacitor
		4	90-08213	Standoffs
	#9	A/R	17-00024	#10 black/wire ground wire
	#10	1	19-05547	I.C.
	#15	1	16-11327	Delay
	#18	1	10-01610	Capacitor
G231	#1	2	90-06892	Standoffs
	#3	16	11-05275	Diode
	#15	A/R	90-09185	Jumper Wire

G110 CONTROL & DATA LOOPS				ETCH	OPTION	OPTION SERIAL #	PDP	SYSTEM SERIAL #	LOCATION	CAB	BOX	SYS UNIT	SLOT	IPB	PAGE		
															1	CP	4
ECO	RELEASE DATE	CS	ETCH WL	ECO HRS. TIME	QUICK CHECK CAUTION - NOT COMPLETE ECO				QTY.	PARTS REQUIRED	MAINDECS REQUIRED	PRINT SET UPDATED	ACTUAL INSTALL TIME	DATE INSTALLED	CE NAME		
00001	03/72	A	C		R118 is a 220 ohm resistor R118 is left of E28 and right of DL3 or possibly under DL3 E28 is the 6th I.C. from BE1 DL3 is the small delay line right of DL1 DL1 is the biggest delay line					N11							
00002	03/72	B	C		DL3 is a 100n sec. delay line with part number D-10100 and/or 1609559 DL3 is a small delay line just right of DL1-08 DL1 is the biggest delay line on board DL3 CHANGED TO 125 N SEC. (P/N-322-1) AND/OR 1611327 BY ECO #15 +15A					N11							
00003	08/72	C	D		R113 is a 120 ohm 1/2W 5% resistor R113 is located at AS1 below DL2 DL2 is between E1 and E2					N11							
B 00004	08/72	D	C	1.0	NOTE: This ECO affects only "C" etch modules R115 is a 1K 1/2W 5% resistor R115 is the 3rd resistor right of DL1-12 DL1 is the biggest delay line				1	13-00365							
B 00005	08/72	E	C	3.0	NOTE: This ECO affects only "C" etch modules C152 is a 6.8 ufd. capacitor with the cathode connected to the + etch on board. C152 is the capacitor right of DL1 -02 DL1 is the biggest delay line				1 4	10-05306 90-08213							

EVEN

ODD

G110 CONTROL & DATA LOOPS		ETCH	OPTION	OPTION SERIAL #	PDP	SYSTEM SERIAL #	LOCATION	CAB	BOX	SYS. UNIT	SLOT	IPB	PAGE 2 OF 4
ECO	RELEASE DATE	CS	ETCH WL	ECO HRS. TIME	QUICK CHECK CAUTION - NOT COMPLETE ECO		QTY.	PARTS REQUIRED	MAINDECS REQUIRED	PRINT SET UPDATED	ACTUAL INSTALL TIME	DATE INSTALLED	CE NAME
00006	11/72	F	E		R123 is a 390 ohm 1/4W 5% resistor R123 is the closest resistor to BS1			N11					
00007	09/72	E1	C		4 - Standoffs <u>screwed</u> on			N11					
00008	10/72	E2	C		C47 is a .01 uf 100V 20% disc capacitor C47 is directly below E40 E40 is the 1st I.C. from CT1 DO NOT COUNT PULSE TRANSFORMER AS I.C.			N/A					
C 00009	12/72	E3	C	.5	Four #18 gauge black ground jumpers on SIDE ONE INSTEAD OF ON SIDE # TWO			17-00024 (#18 black & white teflon coated)					
C 00010 & 10A	11/72	E4	C	1.0	Jumper E15-10 to E28-13 E15 is the 4th I.C. from AV1 E28 is the 6th I.C. from BE1		1	19-05547	DZQKB				
00011	12/72				<u>NOTE:</u> This ECO deleted			N/A					
D 00012	12/72	E5	C	N/A	<u>NOTE:</u> Print update affecting only "C" etch modules.			N11					

G110 CONTROL & DATA LOOPS			ETCH	OPTION	OPTION SERIAL #	PDP	SYSTEM SERIAL #	LOCATION	CAB	BOX	SYS. UNIT	SLOT	IPB	PAGE 3 OF 4
ECO	RELEASE DATE	CS	ETCH WL	ECO HRS. TIME	QUICK CHECK CAUTION - NOT COMPLETE ECO			QTY.	PARTS REQUIRED	MAINDECS REQUIRED	PRINT SET UPDATED	ACTUAL INSTALL TIME	DATE INSTALLED	CE NAME
D 00013 & 13A	01/73	E6	C	.5	NOTE: Rework only "C" etch modules Jumper pin 4 to 13 on spare I.C. slot above E40 E40 is the 1st I.C. from CT1				N11	DZQMB				
00014	03/73	K	F		NOTE: This ECO affects only CS "F" etch "E" modules Jumper E15-10 to E28-13 E15 is the 4th I.C. from AV1 E28 is the 6th I.C. from BE1				N/A					
00014A	03/73	K	F		NOTE: This ECO affects E & F etch revs modules DL3 is 125 n sec. delay line with P/N 1-322-1 and or 1611327 DL3 is small delay line right of the big delay line				N/A					
C 00015 & 15A	05/73	E7	C	1.0	NOTE: This ECO affects "C" etch rev modules DL3 is 125 n sec. delay line with P/N L-00-01 and/or 1611327 DL3 is small delay line right of the big delay line			1	16-11327	DZMMG DZQKB DZQGA				
C 00016	06/73	E8	C	2.0	NOTE: Rework only "C" etch rev modules Jumper E04-04 to E07-07				N11	DZMMG DZQKB DZQGA				
00017	12/73	L	F		NOTE: This ECO affect only "E" & "F" etch rev modules Jumper E04-04 to E07-07				N11					

CONTROL & DATA LOOP				ETCH	OPTION	OPTION SERIAL#	PDP	SYSTEM SERIAL #	LOCATION	CAB	BOX	SYS. UNIT	SLOT	IPB	PAGE 4 OF 4
G110															
ECO	RELEASE DATE	CS	ETCH WL	ECO HRS. TIME	QUICK CHECK CAUTION - NOT COMPLETE ECO			QTY	PARTS REQUIRED	MAINDECS REQUIRED	PRINT SET UPDATE	ACTUAL INSTALL TIME	DATE INSTALLED	CE NAME	
B 00018	10/73	E9	C	1.0	NOTE: Rework etch "C" Rev White wire of twisted pair from E32-06 feed through to E58-14 E32 is the 4th I.C from BS1 E58 is the 1st I.C from FC1			1	10-01610						
C 00019	12/73	E10	C	1.0	NOTE: Rework "C" etch rev Visual check of jumper or etch run from E26-08 to DL1 tap 10 (Do Not Use Meter) E26 is the 4th I.C from BE1 DL1 is the biggest delay line				NIL	DZQMB					
00020 &A	01/74	M	H		NOTE: Affects "F" etch rev Visual check of jumper or etch run from E26-08 to DL1 tap 10 (Do Not Use Meter) E26 is the 4th I.C from BE1 DL1 is the biggest delay line				N/A						
00021	07/74	N N E11 E11	H F E C		NOTE: Phase in DEC 8640's to replace DEC 380's				N/A						
00022	05/76	P	H		NOTE: DEC 7438 allowable I.C. substitution for 74H01-1 at E5, E18-E22				NIL						

EVEN

ODD

G231 MEMORY DRIVER				ETCH	OPTION	OPTION SERIAL #	PDP	SYSTEM SERIAL #	LOCATION	CAB	BOX	SYS. UNIT	SLOT	IPB	PAGE 1 OF 3
ECO	RELEASE DATE	CS	ETCH WL	ECO HRS. TIME	QUICK CHECK CAUTION - NOT COMPLETE ECO			QTY.	PARTS REQUIRED	MAINDECS REQUIRED	PRINT SET UPDATED	ACTUAL INSTALL TIME	DATE INSTALLED	CE NAME	
B 00001	6/72	C	C	3.0	Two standoffs to prevent shorting			2	90-06892						
00002	8/72	D	D		Four standoffs on module				Nil						
D 00003	8/72	E	D	4.0	NOTE: Rework only "C" etch modules D116 is a D672 diode instead of being a resistor D116 is the only diode right of E1			16	11-05275	DZMMI					
00004 & 4A	8/72	F	E		E2 is a DEC I.C. 1074H00 E2 is the I.C. closest to the top left corner.				Nil						
A 00005	8/72	E1	C	4.0	NOTE: Rework only G231's with etch rev "C" which are in 11/05 and ME11 systems. 11/45 memories do <u>not</u> need this ECO Jumper from R101 to Q7 R101 is the 3rd resistor from bottom left corner Q7 is the biggest transistor from E1				Nil						
00006	8/72	E2	C		R170 is a 100 ohm 1/4W 5% resistor R170 is the 2nd resistor from top edge of board in the 1st row of resistors left of E1				Nil						
00007	9/72	E3	C		NOTE: Print update				Nil						

G231 MEMORY DRIVER			ETCH	OPTION	OPTION SERIAL #	PDP	SYSTEM SERIAL #	LOCATION	CAB	BOX	SYS. UNIT	SLOT	IPB	PAGE 2 OF 3
ECO	RELEASE DATE	CS	ETCH WL	ECO HRS. TIME	QUICK CHECK CAUTION - NOT COMPLETE ECO			QTY.	PARTS REQUIRED	MAINDECS REQUIRED	PRINT SET UPDATED	ACTUAL INSTALL TIME	DATE INSTALLED	CE NAME
00008	9/72	E1A E2A E3A	C C C		C52 is a 470 pfd 100V 5% capacitor C52 is at the far left of DR1 and the only component between two transistors				Nil					
D 00009	12/12	E4	C	N/A	NOTE: Field service clarification for etch "C" modules				Nil					
00010	3/73	H	E		E1 is a DEC I.C. 4011 quad transistor				N/A					
00011	4/73	E5	C		E1 is a DEC I.C. 4011 quad transistor				N/A					
00012	4/73	J	E		NOTE: Affects etch "E" rev only R176 is a 4.7K 1/4W 5% resistor R176 is the 1st resistor below two transistors at the far left of EJ1				N/A					
00013	11/73	K	E		NOTE: I.C. substitution cancelled by ECO # 16				N/A					
00014	2/74	L	E		Q12 as snap-on heat sink Q12 is closest transistor to bottom left corner.				N/A					
00015	6/74	M	E ALL		NOTE: This ECO affects all etch rev modules. J1 & J2 have insulated jumper wire J1 & J2 are between E31 and E34 E31 is the last I.C. from CD slot				N/A					
00016	/74	N E6	E C		NOTE: I.C. 380 and 7380 are unsuitable E9, E15, E16, E17 are I.C. DEC 8640's E9 is the last I.C. from AV1 E15 is the 1st I.C. from BF1				N/A					

G231 MEMORY DRIVER		ETCH	OPTION	OPTION SERIAL #	PDP	SYSTEM SERIAL #	LOCATION	CAB	BOX	SYS UNIT	SLOT	IPB	PAGE 3 OF 3
ECO	RELEASE DATE	CS	ETCH WL	ECO HRS. TIME	QUICK CHECK CAUTION - NOT COMPLETE ECO	QTY.	PARTS REQUIRED	MAINDECS REQUIRED	PRINT SET UPDATED	ACTUAL INSTALL TIME	DATE INSTALLED	CE NAME	
00017	01/75	P	E		Q6 is a <u>DEC 6534C</u> transistor Q6 is the <u>last</u> transistor from EJ1		N/A						
00018	04/75	R	E		<u>NOTE:</u> Phase in jumper wire For current loops using teflon insulated wire		N/A						

EVEN

H214 - 8K x 16 BIT MEMORY STACK		ETCH	OPTION	OPTION SERIAL #	PDP	SYSTEM SERIAL #	LOCATION	CAB	BOX	SYS. UNIT	SLOT	IPB	PAGE 1 OF 1
ECO	RELEASE DATE	CS	ETCH NO	ECO HRS. TIME	QUICK CHECK CAUTION - NOT COMPLETE ECO		QTY	PARTS REQUIRED	MAINDECS REQUIRED	PRINT SET UPDATED	ACTUAL INSTALL TIME	DATE INSTALLED	CE
00001	6/72	B			NOTE: Print change			NIL					
00002	1/73	C			NOTE: Reference chart for H214, H215, H216 and G645 etch & CS revs			NIL					
00003	6/73	D			NOTE: Allowable I.C. substitution is DEC 2501 to DEC 2501-01, 2501-02, 2501-03			N/A					
00004	10/73	E			NOTE: Print correction			NIL					
00005	11/73	F			NOTE: Print correction			NIL					
00006	07/74	H			NOTE: Documentation update			NIL					
00007 SA	12/74	J			NOTE: DOCUMENTATION FOR AMPER STACK			NIL					

H214 - 8K x 16 BIT MEMORY STACK		ETCH	OPTION	OPTION SERIAL #	PDP	SYSTEM SERIAL #	LOCATION	CAB	BOX	SYS. UNIT	SLOT	IPB	PAGE 1 OF 1
---------------------------------	--	------	--------	-----------------	-----	-----------------	----------	-----	-----	-----------	------	-----	-------------

ECO	RELEASE DATE	CS	ETCH WL	ECO HRS. TIME	QUICK CHECK CAUTION - NOT COMPLETE ECO	QTY.	PARTS REQUIRED	MAINDECS REQUIRED	PRINT SET UPDATED	ACTUAL INSTALL TIME	DATE INSTALLED	CE NAME
00001	6/72	B			<u>NOTE:</u> Print change		Nil					
00002	1/73	C			<u>NOTE:</u> Reference chart for H214, H215, H216 and G645 etch & CS revs		Nil					
00003	6/73	D			<u>NOTE:</u> Allowable I.C. substitution is DEC 2501 to DEC 2501-01, 2501-02, 2501-03		N/A					
00004	10/73	E			<u>NOTE:</u> Print correction		Nil					
00005	11/73	F			<u>NOTE:</u> Print correction		Nil					
00006	/74	H			<u>NOTE:</u> Documentation update							

MM 1 1 - LP

FCR

B11

MM11-LP
8K 16 BIT PARITY (18 BIT) MEMORY MODULE SET
FCO Cross Reference

**A Chronological Listing of Field Retrofit FCO's Which Must Be
Considered in the Field Installation and Maintenance of This Option/Module/Power Supply**

• Indicates FCO Conjunction Must Be Considered With Prior FCO

- | | |
|--|---|
| <p>1 G231-B0001 MAY 72
QUICK SYNOPSIS
Prevents components on G231 shorting to module above it
QUICK CHECK
Two phenolic 7/16" standoffs on module
NEW REVISION
Rework etch B to CS C</p> | <p>1 G109-C0007 MAR 73
QUICK SYNOPSIS
Eliminates noise coupling onto BUS INIT etch from data line etches
QUICK CHECK
Wire ADD E4 pin 4 to E7 pin 7
NEW REVISION
Rework etch C to CS E</p> |
| <p>2 G231-D0003 AUG 72
QUICK SYNOPSIS
Improves -15V and strobe margins when operating at 55° C
QUICK CHECK
Sixteen D672 diodes replace 330 ohm resistors
NEW REVISION
Rework etch B to CS F</p> | <p>2 C109-C0010 JUL 73
QUICK SYNOPSIS
Eliminates noise-induced condition where memory randomly picks up and drops bits
QUICK CHECK
Twisted pair: E32 pin 6 feed-thru to E58 pin 14 feed thru/E33 pin 7 to ground side of C44
NEW REVISION
Rework etch C to CS E7</p> |
| <p>3 G231-A0005 AUG 72
QUICK SYNOPSIS
Improves AC LO and DC LO circuit operation
QUICK CHECK
Wire ADD from R89 to R93
NEW REVISION
Rework etch C to CS E1</p> | <p>3 G109-C0011 NOV 73
QUICK SYNOPSIS
Lengthens R/W flip-flop reset input pulse to prevent skipped memory cycles on a read
QUICK CHECK
E26 pin 8 goes to top of 10 of the Delay line
NEW REVISION
Rework etch C to CS E8</p> |
| <p>4 G231-D0009 DEC 72
QUICK SYNOPSIS
G231 prints redrawn to DEC standards
NEW REVISION
CS E4</p> | <p>4 G109-C0004 DEC 74
QUICK SYNOPSIS
Replaces +3V with INIT L to reset STROBE one-shot
QUICK CHECK
Wire ADD E28 pin 13 to E15 pin 10
NEW REVISION
Rework etch C. E to CS E3</p> |
| <p>5 G109-C0006 MAR 73
QUICK SYNOPSIS
Lengthens memory cycle time
QUICK CHECK
DL3 replaced with 125 nsec delay
NEW REVISION
Rework etch C to CS E4</p> | |

**ECO
QUICK CHECK**

NOV./74

MM11-LP PARTS BREAKDOWN

G109	- Control & Data Loops
G231	- Memory Driver
H215	- 8K 16 Bit Memory Stack
MM11-LP	- One 8K Parity Memory Bank

MAR/76

MM11-LP FIELD CODED ECO'S

G109

- C4, C6, C7, C10, C11

G231

- B1, D3, A5, D9

REPRODUCTION OF THIS DOCUMENT IS PROHIBITED

JAN./75

MM11-LP ECO PARTS

<u>NAME</u>	<u>ECO #</u>	<u>QTY</u>	<u>PART NUMBER</u>	<u>COMMENTS & DESCRIPTION</u>
G109	# 3, 3A	8	10-00064	Capacitor
		4	10-01610	Capacitor
		1	13-00309	Capacitor
		5	13-05324	Resistor
G109	# 6	1	16-11327	Delay
G109	# 10	1	10-01610	Capacitor
		A/R	91-07720-09	White Wire
G231	# 1	2	90-06892	Standoffs
G231	# 3	16	11-05275	Diode
G231	# 15	A/R	90-09185	Jumper Wire
M7259	# 4	1	13-01874	Resistor
		1	13-09143-11	Resistor

G109 CONTROL & DATA LOOPS		ETCH	OPTION	OPTION SERIAL#	PDP	SYSTEM SERIAL #	LOCATION	CAB	BOX	SYS. UNIT	SLOT	IPB	PAGE 1 OF 3
ECC	RELEASE DATE	CS	ETCH WL	ECO HRS. TIME	QUICK CHECK CAUTION - NOT COMPLETE ECO		QTY	PARTS REQUIRED	MAINDECS REQUIRED	PRINT SET UPDATE	ACTUAL INSTALL TIME	DATE INSTALLED	CE NAM
00001	12/72	F	E		NOTE: New etch Rev			NIL					
00002 &A	12/72	E1	C		Standoffs are screwed on			N/A					
00003 &A	01/73	E2	C		C47 is a .01uf , 100V 20% disc capacitor C47 is directly below E40 E40 is the 1st I.C. from CT1 NOTE: DO NOT COUNT PULSE TRANSFORMER		8 4 1 5	10-000064 10-01610 13-00309 13-05324					
C 00004	01/73	E3	C	2.0	NOTE: Rework G109-YA only for parity memory Jumper from E15-10 to E28-13 E15 is the 4th I.C. from AV1 E28 is the 6th I.C. from BE1			NIL	DZMFA				
00005	05/73	K	F		NOTE: Affects etch "E" and "F" revs DL3 is 125 n sec. delay line with part number L-00-01 and/or 16-11327 DL3 is the small delay line left of E28 E28 is the 6th I.C. from BE1			NIL					
C 00006	05/73	E4	C	1.0	NOTE: Affects etch "C" revs DL3 is a 125 n sec. delay line part number L-00-01 and/or 16-11327 DL3 is a small delay line left of E28 E28 is the 6th I.C. from BE1		1	16-11327	DZMMG DZQMB				

G109 CONTROL & DATA LOOPS		ETCH	OPTION	OPTION SERIAL#	PDP	SYSTEM SERIAL #	LOCATION	CAB	BOX	SYS. UNIT	SLOT	IPB	PAGE 2 OF 3
ECO	RELEASE DATE	CS	ETCH WL	ECO HRS. TIME	QUICK CHECK CAUTION - NOT COMPLETE ECO		QTY	PARTS REQUIRED	MAINDECS REQUIRED	PRINT SET UPDATE	ACTUAL INSTALL TIME	DATE INSTALLED	CE NA.
C 00007	05/73	E5	C	1.0	NOTE: Affects etch "C" rev G109 & G109-YA modules Jumper E04-04 to E07-07			NIL	DZQKB				
00008 &A	06/75	E6	C		NOTE: 1) Affects etch "C" revs. 2) Generate separate G109-YA documentation 3) Change component substitution list R96 is a 82 ohm 1/2W 5% resistor R96 is right of E44 E44 is the 2nd I.C. left of DA1			NIL					
00009	12/73	L	F		NOTE: Affects etch "E" & "F" rev - G109 and G109-YA. Jumper E04-04 to E07-07		1	10-01610					
C 00010	12/73	E7	C	1.0	NOTE: Affects etch "C" rev White jumper from E32-06 to E58-14 E32 is the 4th I.C. from BS1 E58 is the 1st I.C. from FC1		1 A/R	10-01610 91-07720-09					
C 00011	12/73	E8	C	1.0	NOTE: Rework etch "C" rev Jumper or etch run from E26-08 to tap 10 of DL1 E26 is the 4th I.C. from BE1 DL1 is the biggest delay line			NIL	DZQMB				
00012 &A	06/74	M	H		NOTE: Affects etch "F" rev Jumper E26-08 to DL1-10 E26 is the 3rd I.C. from BE1 DL1 is the biggest delay line			N/A					

REVISION DATE MAY/76

G109		CONTROL & DATA LOOPS			ETCH	OPTION	OPTION SERIAL #	PDP	SYSTEM SERIAL #	LOCATION	CAB	BOX	SYS. UNIT	SLOT	IPB	PAGE 3 OF 3
ECO	RELEASE DATE	CS	ETCH WL	ECO HRS. TIME	QUICK CHECK CAUTION - NOT COMPLETE ECO				QTY	PARTS REQUIRED	MAINDECS REQUIRED	PRINT SET UPDATE	ACTUAL INSTALL TIME	DATE INSTALLED	CE NAM	
00013	07/74	E9	C		NOTE: Phase in DEC 8640 to replace DEC 380 and DEC 7380 chips.				8	19-11469						
00014	05/76	P	H		NOTE: DEC 7438 allowable I.C. substitution for 74H01-1 at E5, E18 to E22.					NIL						

EVEN

000

J11

G231 MEMORY DRIVER				ETCH	OPTION	OPTION SERIAL #	PDP	SYSTEM SERIAL #	LOCATION	CAB	BOX	SYS UNIT	SLOT	IPB	PAGE 1 OF 3
ECO	RELEASE DATE	CS	ETCH WL	ECO HRS. TIME	QUICK CHECK CAUTION - NOT COMPLETE ECO			QTY.	PARTS REQUIRED	MAINDECS REQUIRED	PRINT SET UPDATED	ACTUAL INSTALL TIME	DATE INSTALLED	CE MAX	
B 00001	6/72	C	C	3.0	Two standoffs to prevent shorting			2	90-06892						
00002	8/72	D	D		Four standoffs on module				Nil						
D 00003	8/72	E	D	4.0	NOTE: Rework only "C" etch modules D116 is a D672 diode instead of being a resistor D116 is the only diode right of E1			16	11-05275	DZMMI					
00004 & 4A	8/72	F	E		E2 is a DEC I.C. 1074H00 E2 is the I.C. closest to the top left corner.				Nil						
A 00005	8/72	E1	C	4.0	NOTE: Rework only G231's with etch rev "C" which are in 11/05 and ME11 systems. 11/45 memories do not need this ECO Jumper from R101 to Q7 R101 is the 3rd resistor from bottom left corner Q7 is the biggest transistor from E1				Nil						
00006	8/72	E2	C		R170 is a 100 ohm 1/4W 5% resistor R170 is the 2nd resistor from top edge of board in the 1st row of resistors left of E1				Nil						
00007	9/72	E3	C		NOTE: Print update				Nil						

EVEN

ODD

F11

G231 MEMORY DRIVER				ETCH	OPTION	OPTION SERIAL #	PDP	SYSTEM SERIAL #	LOCATION	CAB	BOX	SYS. UNIT	SLOT	IPB	PAGE 2 OF 3
ECO	RELEASE DATE	CS	ETCH WL	ECO HRS. TIME	QUICK CHECK CAUTION - NOT COMPLETE ECO				QTY.	PARTS REQUIRED	MAINDECS REQUIRED	PRINT SET UPDATED	ACTUAL INSTALL TIME	DATE INSTALLED	CE NAME
00008	9/72	E1A E2A E3A	C C C		C52 is a 470 pfd 100V 5% capacitor C52 is at the far left of DR1 and the only component between two transistors					Nil					
D 00009	12/12	E4	C	N/A	NOTE: Field service clarification for etch "C" modules					Nil					
00010	3/73	H	E		E1 is a DEC I.C. 4011 quad transistor					N/A					
00011	4/73	E5	C		E1 is a DEC I.C. 4011 quad transistor					N/A					
00012	4/73	J	E		NOTE: Affects etch "E" rev only R176 is a 4.7K 1/4W 5% resistor R176 is the 1st resistor below two transistors at the far left of EJ1					N/A					
00013	11/73	K	E		NOTE: I.C. substitution cancelled by ECO # 16					N/A					
00014	2/74	L	E		Q12 as snap-on heat sink Q12 is closest transistor to bottom left corner.					N/A					
00015	6/74	M	E ALL		NOTE: This ECO affects all etch rev modules. J1 & J2 have insulated jumper wire J1 & J2 are between E31 and E34 E31 is the last I.C. from CD slot					N/A					
00016	/74	N E6	E C		NOTE: I.C. 380 and 7380 are unsuitable E9, E15, E16, E17 are I.C. DEC 8640's E9 is the last I.C. from AV1 E15 is the 1st I.C. from BF1					N/A					

G231 MEMORY DRIVER				ETCH	OPTION	OPTION SERIAL #	PDP	SYSTEM SERIAL #	LOCATION	CAB	BOX	SYG. UNIT	SLOT	IPB	PAGE 3 OF 3
ECO	RELEASE DATE	CS	ETCH WL	ECO HRS. TIME	QUICK CHECK CAUTION - NOT COMPLETE ECO			QTY.	PARTS REQUIRED	MAINDECS REQUIRED	PRINT SET UPDATED	ACTUAL INSTALL TIME	DATE INSTALLED	CE NAME	
00017	01/75	P	E		Q6 is a DEC 6534C transistor Q6 is the <u>last</u> transistor from EJ1				N/A						
00018	04/75	R	E		<u>NOTE:</u> Phase in jumper wire For current loops using teflon insulated wire				N/A						

REVISION DATE MAR/77

H215 8K x 18 BIT MEMORY STACK		ETCH	OPTION	OPTION SERIAL #	PDP	SYSTEM SERIAL #	LOCATION	CAB	BOX	SYS. UNIT	SLOT	IPB	PAGE 1 OF 1
ECO	RELEASE DATE	CS	ETCH NL	ECO HRS. TIME	QUICK CHECK CAUTION - NOT COMPLETE ECO		QTY	PARTS REQUIRED	MAINDECS REQUIRED	PRINT SET UPDATED	ACTUAL INSTALL TIME	DATE INSTALLED	CS MA
00001	7/73	A			NOTE: Print change			NIL					
00002 6A	12/74				NOTE: DOCUMENTATION FOR AMPEX STACK			NIL					

MM11-S

MM11-S PARTS BREAKDOWN

7008816	-Backplane Assembly
7008855-2B	-11/45 MM11 Power Cable (old)
7008909	-11/40 MM11 Power Cable (old)
7009562	-G772 System Unit Harness (new)
G110	-Control & Data Loops
G231	-Memory Drivers
H214	-8K Bank of Core Memory
BC11-A	-Unibus Cable
M920	-Unibus Jumper
MM11-S	-Single Backplane Unit

DOL

digital EQUIPMENT CORPORATION
MAYNARD MASSACHUSETTS

Engineering Change
Order Log
E
C
D
E
C
O
L
O
G

MM11-S

8K 16 Bit,
890 ns Memory

2356 R624

PROCESSOR TYPE PDP-11/45

MM11S-00001 CODE: D WL: A
APR 72 PROBLEM Missing wires on MM11S back plane for signal
NPGH
CORRECTION Add three wires to Wire List
In plant effectively 01 rework immediately

MM11S-00002 CODE: P
SEP 72 CORRECTION Make corrections to Drawing Directory B10
MM11S
In plant effectively 06 documentation change only

MM11S-00003 CODE: F
OCT 72 PROBLEM Under some conditions when other options are
placed beside an MM11S they fail to operate correctly
CORRECTION Install a #740000 module protection plate

NOTE This FCC is required when other options such as KW1P etc are
physically mounted next to an MM11S memory. Noise generated by the
MM11S may interact with adjacent modules
In plant effectively 02 phase in
Field effectively Retrofit all MM11S memories as required
110 revision B is created Time To Install And Test 3 Hour
Kit Contents FCC Prints And Parts

MM11S-00004 CODE: P DD: C
NOV 72 CORRECTION Add Manufacturing Test Procedures for MM11
K, L, M and N and drawing ANP-MM11S Modules and Systems to
Drawing Directory
In plant effectively 06 documentation change only

**THIS DOCUMENT WAS NOT PRODUCED
FOR MICROFICHE; THEREFORE, ONLY
PARTS OF IT ARE READABLE.**

JUN 7 1976 PAGE 1

EVEN

ODD

013

FCCO'S



ORIGINATOR R. Manion 1-3
 TEL EXT 2005 DATE 10/16/72
 DISC PROJ NO. 896A 06315
 COST CENTER NO. 392
 W.O. 1732

ECO NO. MM11-00003
 SHEET 1 OF 2
 DATE RECEIVED 10-17-72
 FIRST ISSUE 10-19-72
 FINAL ISSUE 11-14-72

PROBLEM
 Under some conditions when other options are placed along side an MM11/S they fail to operate correctly.

UNIT TO BE CHANGED
 MM11/S
 MEMORY
 DISP CODE *02

CORRECTION
 Install a module protection plate.

OPTIONS AFFECTED
 MM11/S
 MM11/SP

BREAK-IN/EFFECTIVITY
 *Install on all units in production.
 Install in field if required.

PRODUCT LINES AFFECTED
 PDP11/45

ITEM NO.	DOCUMENT/PART NO.	OLD REV	NEW REV	DISP CODE	DESCRIPTION OF CHANGE	DOCUMENTATION AFFECTED	FIELD SERVICE AFFECTED	TYPE OF CHANGE	ORDER PR MODEL
1.	B-DD-MM11-S	A	B	06	(Drawing Directory) Change per this ECO. (Module Protection Plate) Add B-MD-7408490-0-0 to drawing directory.	<input type="checkbox"/> MODEL <input type="checkbox"/> DIAGNOSTICS <input type="checkbox"/> TECH MANUAL <input type="checkbox"/> TESTER <input type="checkbox"/> TEST PROG <input type="checkbox"/> TOOLING <input type="checkbox"/> PKG INST <input type="checkbox"/> ENG SPEC <input type="checkbox"/> PURCH SPEC	<input checked="" type="checkbox"/> YES <input type="checkbox"/> NO <input type="checkbox"/> Customer Charge <input checked="" type="checkbox"/> Product Line Charge	<input type="checkbox"/> ELECTRICAL <input checked="" type="checkbox"/> MECHANICAL <input type="checkbox"/> MODULE	<input type="checkbox"/> YES <input checked="" type="checkbox"/> NO

- DISPOSITION CODES**
- 00 - RETURN TO STOCK
 - 01 - (DELETED)
 - 02 - USE PRESENT STOCK UNTIL NEW STOCK AVAILABLE (PHASE IN)
 - 03 - REWORK IMMEDIATELY (RETROFIT)
 - 04 - (DELETED)
 - 05 - (DELETED)
 - 06 - DOCUMENT CORRECTION
 - 07 - NEW ITEM (THIS ASSEMBLY)
 - 08 - NEW ITEM (THIS COMPANY)
 - 09 - SCRAP IMMEDIATELY

APPROVAL SIGNATURES

DESIGN ENGR Pete Durant *P. Durant*
 ENG MGR (OPT) _____
 FIELD SERVICE (OPT) _____
 CHIEF ENGR (MODULES ONLY) _____

MM115 REWORK SHEET

1. LOOSEN 2 SCREWS AT POINTS A. CARE SHOULD BE USED AT ALL TIME SO THAT NO WIRES ARE DAMAGED.
2. SLIDE THE FINGERS OF THE MODULE PROTECTION PLATE UNDER THE GND LUGS. THE PROTECTION PLATE SHOULD BE RIGHT AGAINST THE WIRED ASSY. FRAME, POINT B.
3. TIGHTEN SCREWS.

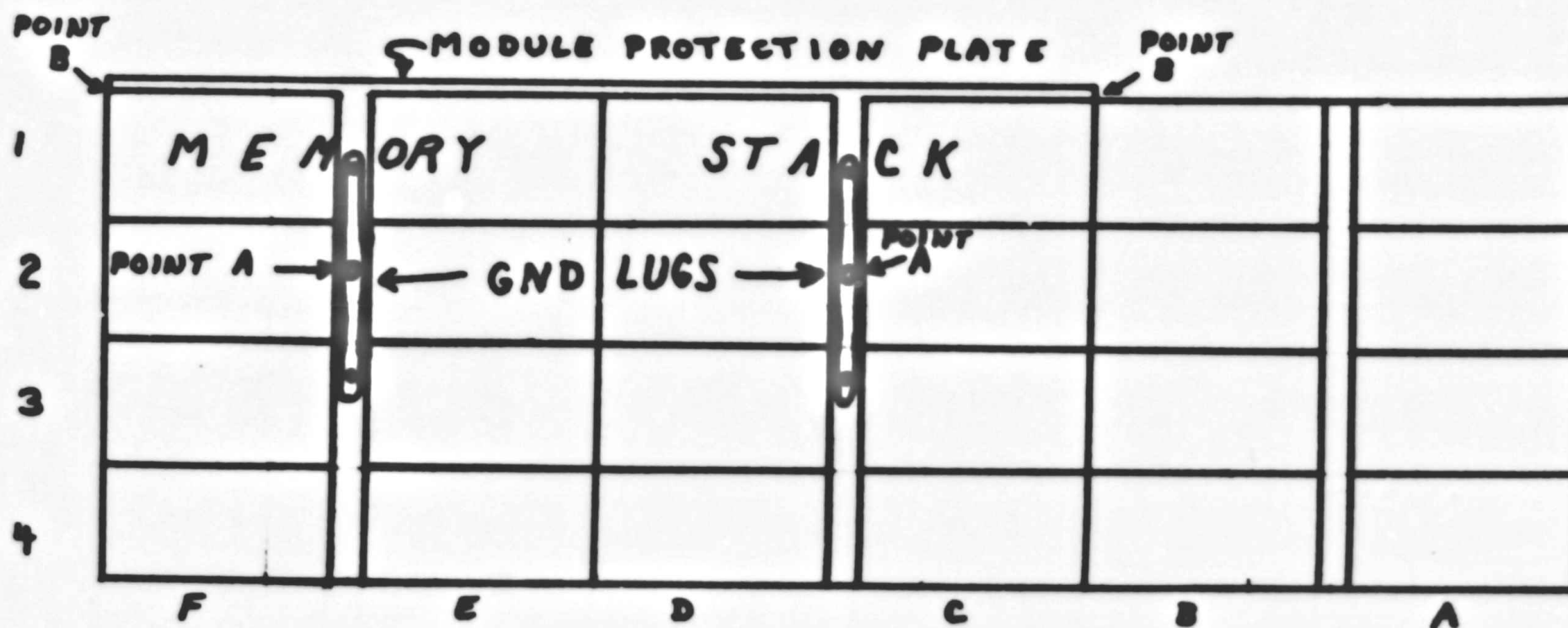

digital

FIELD CHANGE ORDER

FCO MM1S - C 0003

PAGE OF

DATA PROCESSING AND DEC ECO LOGS WILL POST THIS FCO WITH THE LEVEL OF URGENCY CODE REPLACING THE LEADING ZERO.

FIELD EFFECTIVITY
Retrofit all MM1-S memories as required

*** LEVEL OF URGENCY CODE**

- A MANDATORY - HIGH PRIORITY
- B MANDATORY
- C HIGH PRIORITY IF SPECIFIC HARDWARE, SOFTWARE, OR SYMPTOMS ARE PRESENT
- D APPLICABLE IF SPECIFIC HARDWARE, SOFTWARE, OR SYMPTOMS ARE PRESENT
- E PRODUCT IMPROVEMENT - OPTIONAL - LOW PRIORITY

FIELD RETROFIT IS ANTICIPATED IN % OF UNITS DEFINED ABOVE

NO CHARGE TO CUSTOMER ALL DEC INSTALLATION LABOR AND MATERIAL ARE TO BE REPORTED UNDER A "W" CHARGE CODE.

STANDARD APPLICABILITY THIS FCO IS TO BE INSTALLED AT NO CHARGE FOR WARRANTY AND MAINTENANCE CONTRACT CUSTOMERS IN ACCORDANCE WITH THE TECHNICAL EFFECTIVITY ABOVE, OTHERWISE AT CUSTOMER EXPENSE

DOCUMENTATION \$ PARTS \$ DEC ON-SITE LABOR \$

DEC'S MINIMUM BILLING APPLIES IF THIS FCO IS INSTALLED BY DEC. THE DEC LABOR CHARGE ASSUMES FCO INSTALLATION DURING REGULAR WORKING HOURS IF INSTALLATION OUTSIDE OF REGULAR WORKING HOURS IS ORDERED. DEC'S LATEST SCHEDULE OF HOURLY RATES WILL APPLY.

DISCRIPTOR PROJECT NUMBER
(FOR FIELD SERVICE REPORTING) W67

AVAILABILITY DELAY
PARTS None NO PARTS

ESTIMATED DOWN TIME FOR INSTALLATION AND TESTING
0.5 HOURS

SPECIAL TEST EQUIPMENT TOOLS, OR SUPPLIES

FIELD OFFICE FCO DISTRIBUTION (UEN)

- F** IMMEDIATE FCO DISTRIBUTION TO ALL DEC FIELD OFFICES
- RF** IMMEDIATE FCO DISTRIBUTION TO REGIONAL PRODUCT SUPPORT

FCO KIT DISTRIBUTION

K KITS, AS DEFINED BELOW, MAY BE ORDERED AS REQUIRED.

CONTENTS OF AN FSIC INITIATED KIT

FIO	FCO	PRINTS	PARTS

FSIC INITIATED FCO KITS WILL BE DISTRIBUTED FOR ALL UNITS LISTED ON THE EDP CONFIGURATION FILE WITH THE FOLLOWING SERVICE STATUS CODES

D	H	A	W		
---	---	---	---	--	--

CONTENTS OF A FIELD ORDERED KIT

FIO	FCO	PRINTS	PARTS
	X	X	X

LAST PREVIOUS FCO'S None

RELATED OR PREREQUISITE FCO'S

- MAINDEC CHANGE
- MAINTENANCE MANUAL CHANGE
- OPERATIONAL PROGRAMS AFFECTED

VERIFICATION MAINDECS

11-DZQMB

INSTALLATION AND TEST PROCEDURES

PARTS REQUIRED

Q1 74-08490 Module protection plate

NOTES This FCO is required when other options such as KW1-P, etc. are physically mounted next to an MM1-S memory. Noise generated by the MM1-S may interact with adjacent modules.

FIELD SERVICE APPROVAL

Art Zins

awk

10/30 450

THIS DOCUMENT WAS NOT PRODUCED FOR MICROFICHE; THEREFORE, ONLY PARTS OF IT ARE READABLE.

H13

FCR

213

MM11-S
8K, 16 BIT 18 MIL MEMORY
FCO Cross Reference

**A Chronological Listing of Field Retrofit FCO's Which Must Be
Considered in the Field Installation and Maintenance of This Option/Module/Power Supply**

• Indicates FCO Conjunction Must Be Considered With Prior FCO

- **G231-B0001 MAY 71**
QUICK SYNOPSIS
Prevents components on G231 shorting to module above it.
QUICK CHECK
Two phenolic 7/16" standoffs on module.
NEW REVISION
Rework etch B to CS C.
- **G110-B0004 MAY 72**
QUICK SYNOPSIS
Corrects delay line 3 termination on C etch G110's.
QUICK CHECK
R115 changed from 3K to 1K ohm.
NEW REVISION
Rework etch C to CS D.
- **G110-B0005 MAY 72**
QUICK SYNOPSIS
Corrects C152 insertion polarity (positive terminal) to +5V.
QUICK CHECK
Positive terminal of C152 goes to +5V.
NEW REVISION
Rework etch C, D to CS E.
- **G231-D0003 AUG 72**
QUICK SYNOPSIS
Improves -15V and strobe margins when operating at 55°C.
QUICK CHECK
Sixteen D672 diodes replace 330 ohm resistors.
NEW REVISION
Rework etch B to CS F.
- **G231-A0005 AUG 72**
QUICK SYNOPSIS
Improves AC LO and DC LO circuit operation.
QUICK CHECK
Wire ADD from R89 to R93.
NEW REVISION
Rework etch C to CS E1.
- **G110-D0012 DEC 72**
QUICK SYNOPSIS
Provides print clarification affecting etch C G110's.
NEW REVISION
CS E5
- **G110-D0013 DEC 72**
QUICK SYNOPSIS
Ensures PAL and PBL data bits gate high onto the Bus.
QUICK CHECK
Wire ADD's E40 pin 4 to pin 13 and E40 pin 9 to pin 12.
NEW REVISION
Rework etch C to CS E6.
- **G110-C0015 MAR 73**
QUICK SYNOPSIS
Allows longer memory cycle time on systems with high speed NPR devices.
QUICK CHECK
DL3 changed from 100nsec to 125nsec delay.
NEW REVISION
Rework etch C to CS E7.
- **G110-C0016 MAR 73**
QUICK SYNOPSIS
Eliminates noise on BUS INIT etch.
QUICK CHECK
Wire ADD'S E4 pin 4 to E7 pin 7, AA1 feed-thru to E7 pin 6.
NEW REVISION
Rework etch C to CS E8.

**MM11-S
8K, 16 BIT 18 MIL MEMORY
FCO Cross Reference**

**A Chronological Listing of Field Retrofit FCO's Which Must Be
Considered in the Field Installation and Maintenance of This Option/Module/Power Supply**

• Indicates FCO Conjunction Must Be Considered With Prior FCO

10 G110-B0018 APR 73

QUICK SYNOPSIS

Eliminates noise on STROBE O H etch.

QUICK CHECK

E32 pin 8 feed-thru to E58 pin 4 feed-
thru/E33 pin 7 to ground side of C44.

NEW REVISION

Rework etch C to CS E9.

11 G110-C0019 NOV 73

QUICK SYNOPSIS

Lengthening R/W RESET L prevents memory
skipping a Restore cycle.

QUICK CHECK

E28 pin 8 goes to Tap 10 of Delay line.

NEW REVISION

Rework etch C to CS E10.

12 MM11S-C0003 OCT 73

QUICK SYNOPSIS

Module protection plate eliminates MM11-S
noise interaction with adjacent modules.

QUICK CHECK

Presence of protection plate.

FCR Page 2. Revision ""

**ECO
QUICK CHECK**

NOV/74

MM11-S PARTS BREAKDOWN

7008816	-Backplane Assembly
7008855-2B	-11/45 MM11 Power Cable (old)
7008909	-11/40 MM11 Power Cable (old)
7009562	-G772 System Unit Harness (new)
G110	-Control & Data Loops
G231	-Memory Drivers
H214	-8K Bank of Core Memory
BC11-A	-Unibus Cable
M920	-Unibus Jumper
MM11-S	-Single Backplane Unit

MB-

JAN/75

MM11-S ECO PARTS

<u>NAME</u>	<u>ECO #</u>	<u>QTY</u>	<u>PART NUMBER</u>	<u>COMMENTS & DESCRIPTION</u>
G110	# 4	1	13-00365	Resistor
	# 5	1	10-05306	Capacitor
		4	90-08213	Standoffs
	# 9	A/R	17-00024	# 10 black/white gd.wire
	#10	1	19-05547	I.C.
	#15	1	16-11327	Delay
	#18	1	10-01610	Capacitor
G231	# 1	2	90-06892	Standoffs
	# 3	16	11-05275	Diode
	#15	A/R	90-09185	Jumper wire
MM11-S	# 3	1	74-08490	Shield

MM11-S FIELD CODED ECO'S

G110	B4, B5, C9, C10 & A, D12, D13 & A, C15 & A, C16, B18, C19
G231	B1, D3, A5, D9
MM11-S	C3

MM11-S 8K 16 BIT MEMORY				ETCH	OPTION	OPTION SERIAL #	PDP	SYSTEM SERIAL #	LOCATION	CAB	BOX	SYS. UNIT	SLOT	IPB	PAGE 1 OF 1
ECO	RELEASE DATE	CS	ETCH WL	ECO HRS. TIME	QUICK CHECK CAUTION - NOT COMPLETE ECO			QTY	PARTS REQUIRED	MAINDECS REQUIRED	PRINT SET UPDATED	ACTUAL INSTALL TIME	DATE INSTALLED	CE NAME	
00001	4/72		A		Jumper A01-U1 to A02-U1				Nil						
00002	9/72				<u>NOTE:</u> Print change				Nil						
C 00003	10/72			.5	A module protection plate beside MM11-S memory bank.			1	74-08490						
00004	11/72				<u>NOTE:</u> Adds test procedures for MM11-K, L, M, S and SP modules and systems				Nil						
00005	10/73				Jumper C02-A2 to F01-A2				Nil						
00006	2/74				<u>NOTE:</u> New harness (7009562) introduced for 15 pin power distribution. 11/40 and 11/45 with serial numbers greater than 6000 and 2000 respectively have a G772 system unit harness				N/A						
00007	05/75				<u>NOTE:</u> Document update				NIL						
00008	05/76				<u>NOTE:</u> Documentation update				NIL						

G110 CONTROL & DATA LOOPS		ETCH	OPTION	OPTION SERIAL #	PDP	SYSTEM SERIAL #	LOCATION	CAB	BOX	SYS. UNIT	SLOT	IPB	PAGE
													1 OF 4
ECO	RELEASE DATE	CS	ETCH WL	ECO HRS. TIME	QUICK CHECK CAUTION - NOT COMPLETE ECO	QTY.	PARTS REQUIRED	MAINDECS REQUIRED	PRINT SET UPDATED	ACTUAL INSTALL TIME	DATE INSTALLED	CE NAME	
00001	03/72	A	C		R118 is a 220 ohm resistor R118 is left of E28 and right of DL3 or possibly under DL3 E28 is the 6th I.C. from BE1 DL3 is the small delay line right of DL1 DL1 is the biggest delay line		N11						
00002	03/72	B	C		DL3 is a 100n sec. delay line with part number D-10100 and/or 1609559 DL3 is a small delay line just right of DL1-08 DL1 is the biggest delay line on board <u>DL3 CHANGED TO 125 N SEC. (P/N-322-1)</u> <u>AND/OR 1611327 BY ECO #15 +15A</u>		N11						
00003	08/72	C	D		R113 is a 120 ohm 1/2W 5% resistor R113 is located at AS1 below DL2 DL2 is between E1 and E2		N11						
B 00004	08/72	D	C	1.0	<u>NOTE: This ECO affects only "C" etch modules</u> R115 is a 1K 1/2W 5% resistor R115 is the 3rd resistor right of DL1-12 DL1 is the biggest delay line	1	13-00365					DZMMG DZMMI	
B 00005	08/72	E	C	3.0	<u>NOTE: This ECO affects only "C" etch modules</u> C152 is a 6.8 ufd. capacitor with the cathode connected to the + etch on board. C152 is the capacitor right of DL1 -02 DL1 is the biggest delay line	1 4	10-05306 90-08213						

G110 CONTROL & DATA LOOPS				ETCH	OPTION	OPTION SERIAL #	PDP	SYSTEM SERIAL #	LOCATION	CAB	BOX	SYS. UNIT	SLOT	IPB	PAGE 2 OF 4
ECO	RELEASE DATE	CS	ETCH WL	ECO HRS. TIME	QUICK CHECK CAUTION - NOT COMPLETE ECO			QTY.	PARTS REQUIRED	MAINDECS REQUIRED	PRINT SET UPDATED	ACTUAL INSTALL TIME	DATE INSTALLED	CB NAME	
00006	11/72	F	E		R123 is a 390 ohm 1/4W 5% resistor R123 is the closest resistor to BS1				N11						
00007	09/72	E1	C		4 - Standoffs <u>screwed</u> on				N11						
00008	10/72	E2	C		C47 is a .01 uf 100V 20% disc capacitor C47 is directly below E40 E40 is the 1st I.C. from CT1 DO NOT COUNT PULSE TRANSFORMER AS I.C.				N/A						
C 00009	12/72	E3	C	.5	Four #18 gauge black ground jumpers on SIDE ONE INSTEAD OF ON SIDE # TWO				17-00024 (#18 black & white teflon coated)						
C 00010 & 10A	11/72	E4	C	1.0	Jumper E15-10 to E28-13 E15 is the 4th I.C. from AV1 E28 is the 6th I.C. from BE1			1	19-05547	DZQKB					
00011	12/72				<u>NOTE:</u> This ECO deleted				N/A						
D 00012	12/72	E5	C	N/A	<u>NOTE:</u> Print update affecting only "C" etch modules.				N11						

G110 CONTROL & DATA LOOPS		ETCH	OPTION	OPTION SERIAL #	PDP	SYSTEM SERIAL #	LOCATION	CAB	BOX	SYS. UNIT	SLOT	IPB	PAGE
													3 OF 4
ECO	RELEASE DATE	CS	ETCH WL	ECO HRS. TIME	QUICK CHECK CAUTION - NOT COMPLETE ECO		QTY.	PARTS REQUIRED	MAINDECS REQUIRED	PRINT SET UPDATED	ACTUAL INSTALL TIME	DATE INSTALLED	CE NAME
D 00013 & 13A	01/73	E6	C	.5	NOTE: Rework only "C" etch modules Jumper pin 4 to 13 on spare I.C. slot above E40 E40 is the 1st I.C. from CT1			N11	DZQMB				
00014	03/73	K	F		NOTE: This ECO affects only CS "F" etch "E" modules Jumper E15-10 to E28-13 E15 is the 4th I.C. from AV1 E28 is the 6th I.C. from BE1			N/A					
00014A	03/73	K	F		NOTE: This ECO affects E & F etch revs modules DL3 is 125 n sec. delay line with P/N 1-322-1 and or 1611327 DL3 is small delay line right of the big delay line			N/A					
C 00015 & 15A	05/73	E7	C	1.0	NOTE: This ECO affects "C" etch rev modules DL3 is 125 n sec. delay line with P/N L-00-01 and/or 1611327 DL3 is small delay line right of the big delay line		1	16-11327	DZMMG DZQKB DZQGA				
C 00016	06/73	E8	C	2.0	NOTE: Rework only "C" etch rev modules Jumper E04-04 to E07-07			N11	DZMMG DZQKB DZQGA				
00017	12/73	L	F		NOTE: This ECO affect only "E" & "F" etch rev modules Jumper E04-04 to E07-07			N11					

CONTROL & DATA LOOP				ETCH	OPTION	OPTION SERIAL #	PDP	SYSTEM SERIAL #	LOCATION	CAB	BOX	SYS. UNIT	SLOT	IPB	PAGE 4 OF 4
G110															
ECO	RELEASE DATE	CS	ETCH WL	ECO HRS. TIME	QUICK CHECK CAUTION - NOT COMPLETE ECO	QTY	PARTS REQUIRED	MAINDECS REQUIRED	PRINT SET UPDATE	ACTUAL INSTALL TIME	DATE INSTALLED	CE NAME			
B 00018	10/73	E9	C	1.0	NOTE: Rework etch "C" Rev White wire of twisted pair from E32-06 feed through to E58-14 E32 is the 4th I.C from BS1 E58 is the 1st I.C from FC1	1	10-01610								
C 00019	12/73	E10	C	1.0	NOTE: Rework "C" etch rev Visual check of jumper or etch run from E26-08 to DL1 tap 10 (Do Not Use Meter) E26 is the 4th I.C from BE1 DL1 is the biggest delay line		NIL	DZQMB							
00020 &A	01/74	M	H		NOTE: Affects "F" etch rev Visual check of jumper or etch run from E26-08 to DL1 tap 10(Do Not Use Meter) E26 is the 4th I.C from BE1 DL1 is the biggest delay line		N/A								
00021	07/74	N N E11 E11	H F E C		NOTE: Phase in DEC 8640's to replace DEC 380's		N/A								
00022	09/76	P	H		NOTE: DEC 7438 allowable I.C. substitution for 74H01-1 at E5, E18-E22		NIL								

G231 MEMORY DRIVER		ETCH	OPTION	OPTION SERIAL #	PDP	SYSTEM SERIAL #	LOCATION	CAB	BOX	SYS. UNIT	SLOT	IPB	PAGE 1 OF 3
ECO	RELEASE DATE	CS	ETCH WL	ECO HRS. TIME	QUICK CHECK CAUTION - NOT COMPLETE ECO		QTY.	PARTS REQUIRED	MAINDECS REQUIRED	PRINT SET UPDATED	ACTUAL INSTALL TIME	DATE INSTALLED	CE NAME
B 00001	6/72	C	C	3.0	Two standoffs to prevent shorting		2	90-06892					
00002	8/72	D	D		Four standoffs on module			Nil					
D 00003	8/72	E	D	4.0	NOTE: Rework only "C" etch modules D116 is a D672 diode instead of being a resistor D116 is the only diode right of E1		16	11-05275	DZMMI				
00004 & 4A	8/72	F	E		E2 is a DEC I.C. 1074H00 E2 is the I.C closest to the top left corner.			Nil					
A 00005	8/72	E1	C	4.0	NOTE: Rework only G231's with etch rev "C" which are in 11/05 and ME11 systems. 11/45 memories do <u>not</u> need this ECO Jumper from R101 to Q7 R101 is the 3rd resistor from bottom left corner Q7 is the biggest transistor from E1			Nil					
00006	8/72	E2	C		R170 is a 100 ohm 1/4W 5% resistor R170 is the 2nd resistor from top edge of board in the 1st row of resistors left of E1			Nil					
00007	9/72	E3	C		NOTE: Print update			Nil					

EVEN

H14

231 MEMORY DRIVER				ETCH	OPTION	OPTION SERIAL #	PDP	SYSTEM SERIAL #	LOCATION	CAB	BOX	SYS. UNIT	SLOT	IPB	PAGE 2 OF 3
ECO	RELEASE DATE	CS	ETCH WL	ECO HRS. TIME	QUICK CHECK CAUTION - NOT COMPLETE ECO			QTY.	PARTS REQUIRED	MAINDECS REQUIRED	PRINT SET UPDATED	ACTUAL INSTALL TIME	DATE INSTALLED	CE NAME	
00008	9/72	E1A E2A E3A	C C C		C52 is a 470 pfd 100V 5% capacitor C52 is at the far left of DR1 and the only component between two transistors				Nil						
00009	12/12	E4	C	N/A	NOTE: Field service clarification for etch "C" modules				Nil						
00010	3/73	H	E		E1 is a DEC I.C. 4011 quad transistor				N/A						
00011	4/73	E5	C		E1 is a DEC I.C. 4011 quad transistor				N/A						
00012	4/73	J	E		NOTE: Affects etch "E" rev only R176 is a 4.7K 1/4W 5% resistor R176 is the 1st resistor below two transistors at the far left of EJ1				N/A						
00013	11/73	K	E		NOTE: I.C. substitution cancelled by ECO # 16				N/A						
00014	2/74	L	E		Q12 as snap-on heat sink Q12 is closest transistor to bottom left corner.				N/A						
00015	6/74	M	E ALL		NOTE: This ECO affects all etch rev modules. J1 & J2 have insulated jumper wire J1 & J2 are between E31 and E34 E31 is the last I.C. from CD slot				N/A						
00016	/74	N E6	E C		NOTE: I.C. 380 and 7380 are unsuitable E9, E15, E16, E17 are I.C. DEC 8640's E9 is the last I.C. from AV1 E15 is the 1st I.C. from BF1				N/A						

G231 MEMORY DRIVER				ETCH	OPTION	OPTION SERIAL #	PDP	SYSTEM SERIAL #	LOCATION	CAB	BOX	SYS UNIT	SLOT	IPB	PAGE 3 OF 3
ECO	RELEASE DATE	CS	ETCH WL	ECO HRS. TIME	QUICK CHECK CAUTION - NOT COMPLETE ECO			QTY.	PARTS REQUIRED	MAINDECS REQUIRED	PRINT SET UPDATED	ACTUAL INSTALL TIME	DATE INSTALLED	CE NAME	
00017	01/75	P	E		Q6 is a DEC 6534C transistor Q6 is the <u>last</u> transistor from EJ1				N/A						
00018	04/75	R	E		<u>NOTE:</u> Phase in jumper wire For current loops useing teflon insulated wire				N/A						

EVEN

J14

H214 - 8K x 16 BIT MEMORY STACK		ETCH	OPTION	OPTION SERIAL #	PDP	SYSTEM SERIAL #	LOCATION	CAB	BOX	SYS. UNIT	SLOT	IPB	PAGE 1 OF 1
ECO	RELEASE DATE	CS	ETCH WL	ECO HRS. TIME	QUICK CHECK CAUTION - NOT COMPLETE ECO		QTY	PARTS REQUIRED	MAINDECS REQUIRED	PRINT SET UPDATED	ACTUAL INSTALL TIME	DATE INSTALLED	CE NO.
00001	6/72	B			NOTE: Print change			Nil					
00002	1/73	C			NOTE: Reference chart for H214, H215, H216 and G645 etch & CS revs			Nil					
00003	6/73	D			NOTE: Allowable I.C. substitution is DEC 2501 to DEC 2501-01, 2501-02, 2501-03			N/A					
00004	10/73	E			NOTE: Print correction			Nil					
00005	11/73	F			NOTE: Print correction			Nil					
00006	07/74	H			NOTE: Documentation update			NIL					
00007 SA	12/74	J			NOTE: DOCUMENTATION FOR AMPEX STACK			NIL					

MM11-U/UP

FCR

**MM11-U
16K CORE MEMORY/PARITY
FCO Cross Reference**

**A Chronological Listing of Field Retrofit FCO's Which Must Be
Considered in the Field Installation and Maintenance of This Option/Module/Power Supply**

• Indicates FCO Conjunction Must Be Considered With Prior FCO

I G235-S0009 SEP 76

QUICK SYNOPSIS

Marginal memory under conditions of high
drive current

QUICK CHECK

750 ohm resistor at + symbol near large etch

NEW REVISION

Rework etch D to CS N

**ECO
QUICK CHECK**

D15

APRIL/77

NOTE: 1) MM11-U/UP are combined together for convenience

MM11-U/UP PARTS BREAKDOWN

G114	- 16K sense memory
G235	- 16K X-Y driver
H217-C	- parity memory stack (16K X 18 bit)
H217-D	- memory stack (16K X 16 bit)
M8239	- 16K timing module
MM11-U/UP	- 16K Core Memory/Parity

MM11-U/UP FIELD CODED ECO's

G114	- 15
G235	- 59

MM11-U/UP ECO PARTS

<u>NAME</u>	<u>ECO#</u>	<u>QTY</u>	<u>PART NUMBER</u>	<u>COMMENTS & DESCRIPTION</u>
G235	#9	1	13-05281-00	RESISTOR

G114 16K SENSE INHIBIT		ETCH	OPTION	OPTION SERIAL #	PDP	SYSTEM SERIAL #	LOCATION	CAB	BOX	SYS. UNIT	SLOT	IPB	PAGE 1 OF 1
ECO	RELEASE DATE	CS	ETCH WL	ECO HRS. TIME	QUICK CHECK CAUTION - NOT COMPLETE ECO	QTY	PARTS REQUIRED	MAINDECS REQUIRED	PRINT SET UPDATED	ACTUAL INSTALL TIME	DATE INSTALLED	CE NAME	
00001	10/73	B	B		<u>NOTE:</u> Cancelled By ECO# 1A		NIL						
00001A	10/73	B	B		Gnd Jumper from FT1 and along the bottom of the board	A/R	91-07470-00						
00002	11/73	C	B		R108 is a <u>56 OHM</u> , 1/2W, 5% resistor R108 to the right of T103 T103 is a transformer along AC1 near handle side.		N/A						
00003	10/74	D	C		<u>NOTE:</u> New Etch Rev.		NIL						
00004	04/75	E	C		<u>NOTE:</u> Part substitution due to shortage		N/A						
I 00005	05/75	F	C	.5	<u>NOTE:</u> Affects only etch "C" rev's Measure open circuit from the top left metal handle to ground		NIL						

G235		16K X-Y DRIVER		ETCH	OPTION	OPTION SERIAL#	PDP	SYSTEM SERIAL #	LOCATION	CAB	BOX	SYS. UNIT	SLOT	IPB	PAGE 1 OF 2
					MF11-U										
ECO	RELEASE DATE	CS	ETCH WL	ECO HRS. TIME	QUICK CHECK CAUTION - NOT COMPLETE ECO			QTY	PARTS REQUIRED	MAINDECS REQUIRED	PRINT SET UPDATE	ACTUAL INSTALL TIME	DATE INSTALLED	CE NAME	
00001	07/73	D	D		R35 is a 3.16K, 1/8W, 1% resistor R35 is located below W4 W4 is left of E2-01 E2 is the 2nd I.C. from AT1			1 1	13-00229 13-03045						
00002	09/73	E	D		R92 is NOT a 330ohm, 1/2W, 5% resistor R92 is the 4th component above R101 R101 is 220 ohm, 2W resistor left at AT1			1 2 1	11-03441 13-00271 13-02379						
00003	11/73	F	D		R29 is a 120K, 1/2W 5% resistor R29 is the 1st resistor above Q14 Q14 is the transistor above E4 E4 is the 2nd I.C. from BL1				N/A						
00004	01/74	H	D		D2, D3, D4 are deleted No diodes between E2 and R18 R18 is a 100ohm resistor, above E2			1 1	15-05321 19-10466						
00005	04/74	J	D		C47 is a .022 ufd capacitor C47 is the 1st capacitor below T2 T2 is a transformer at the far left of AN1			2 1	10-11683 13-04855						
00006	08/74	K	D		Delete C44 Only one 47ufd, 20V, 10% capacitor still present (not two) between Q12 and Q13 Q12 and Q13 are the 1st and 2nd transistors from AE1				NIL						

G235 16K X-Y DRIVER		ETCH	OPTION	OPTION SERIAL#	PDP	SYSTEM SERIAL #	LOCATION	CAB	BOX	SYS. UNIT	SLOT	IPB	PAGE 2 OF 2
ECO	RELEASE DATE	CS	ETCH WL	ECO HRS. TIME	QUICK CHECK CAUTION - NOT COMPLETE ECO		QTY	PARTS REQUIRED	MAINDECS REQUIRED	PRINT SET UPDATE	ACTUAL INSTALL TIME	DATE INSTALLED	CE NAME
00007	04/75	L	D		NOTE: Parts substitution due to shortages			NIL					
I 00008	06/75	L	D		NOTE: Must have if used on MA20-M for PDP10 R23 is an 1K 1/2W resistor R23 is the only resistor left of AAl		1 1	13-00364 13-02388					
I 00009 6A	06/76	N	D		R103 is a 75 ohm 1W 5% resistor R103 is immediately right of Q12 Q12 is the 2nd transistor from AC1								

H15

H217	16K STACK	ETCH	OPTION	OPTION SERIAL #	PDP	SYSTEM SERIAL #	LOCATION	CAD	BOX	SYS. UNIT	SLOT	IPB	PAGE 1 OF 1
------	-----------	------	--------	-----------------	-----	-----------------	----------	-----	-----	-----------	------	-----	----------------

ECO	RELEASE DATE	CS	ETCH WL	ECO HRS. TIME	QUICK CHECK <u>CAUTION - NOT COMPLETE ECO</u>	QTY	PARTS REQUIRED	MAINDECS REQUIRED	PRINT SET UPDATED	ACTUAL INSTALL TIME	DATE INSTALLED	CB NAME
00001	05/74				<u>NOTE:</u> Manufacturing Change		NIL					
00002	07/74				<u>NOTE:</u> Document Change		NIL					
00003	10/74	B	E		<u>NOTE:</u> Rework H217-B and C (18 or 19 Bit) Diodes D29, D30 are deleted D29, D30 were Diodes left of CE1 but right of the resistor network		NIL					
00004	03/76	C	E		<u>NOTE:</u> Manufacturing change.		NIL					

M8293		16K UNIBUS TIMING		ETCH	OPTION	OPTION SERIAL#	PDP	SYSTEM SERIAL #	LOCATION	CAB	BOX	SYS. UNIT	SLOT	IPB	PAGE 1 OF 1
ECO	RELEASE DATE	CS	ETCH WL.	ECO HRS. TIME	QUICK CHECK CAUTION - NOT COMPLETE ECO			QTY	PARTS REQUIRED	MAINDECS REQUIRED	PRINT SET UPDATE	ACTUAL INSTALL TIME	DATE INSTALLED	CE NAME	
00001	10/73	B	B		NOTE: This is a mandatory ECO Measure continuity from E21-03 to E25-13 E21 is the 2nd I.C. from CL1 E25 is below E21				NIL						
00002	11/73	C	B		NOTE: This is a mandatory ECO Measure continuity from E03-05 to DL3-05 DL3 is the only delay line left of AR1				NIL						
00003 LA	06/74	D	C		NOTE: New etch rev				N/A						
00004	06/75	E	C		NOTE: Phase in DEC 8640 to replace DEC 380				N/A						
00005	06/76	F	C B		NOTE: Introduces M8293-YB for XM15 M8293-YB can be distinguished by checking for jumper from E38-12 to E38-13 E38 is the 4th I.C. from DT1				NIL						

EVEN

J15